



7.1.4: the Institutional efforts/initiatives in providing an inclusive environment i.e., tolerance and harmony towards cultural, regional, linguistic, communal socioeconomic diversity and Sensitization of students and employees to the constitutional obligations: values, rights, duties and responsibilities of citizens

Various initiatives in the form of celebration of National and international days, National Festivals, NSS activities, etc. are adopted by bringing students and teachers with diverse background on single platform for creating inclusive environment. These activities help in developing tolerance and harmony towards culture, region and linguistics and also communal social economics and other diversities.

Functions like, welcome ceremony for freshly admitted students with induction program and farewells for outgoing batch is a regular practice. Days like traditional day, Marathi Bhasha Din, Shivajayanti, etc. are celebrated annually

ZEAL INSTITUTE'S
www.zealeducation.com
NARHE | PUNE | INDIA

YOU ARE INVITED TO
"Deeksharambh"
SE INDUCTION PROGRAM
2021-22

DEPARTMENT OF
ELECTRICAL ENGINEERING

SATURDAY
AUGUST 21st
2021

Scan to Join

OR
Video call Link:
<https://argo.page.link/jGD7j>

Time
10:00 AM Onwards

VISION OF DEPARTMENT
To build students technologically and ethically strong to meet the advanced technological challenges for the benefit of society and engineering industries.

Prof. Sudhir Mane
HoD, Electrical

Dr. Ajit Kate
Principal, ZCOER, Pune

Follow us at : zealinstitutes 



Shivajayanti



Traditional Day



**ZEAL EDUCATION SOCIETY'S
ZEAL COLLEGE OF ENGINEERING AND RESEARCH
NARHE | PUNE -41 | INDIA**



Considering entry level curriculum of engineering student one foreign language training was planned and around 300 students were trained for Japanese Language. This helped to get acquainted with Japanese literature and culture.

ZEAL INSTITUTE'S **25** **ZEAL COLLEGE OF ENGINEERING & RESEARCH, PUNE**
www.zealeducation.com **ZEAL CENTRAL PLACEMENT CELL**
ESTD-1996 NARHE | PUNE | INDIA

Webinar on
"LEARN JAPANESE - OPPORTUNITIES IN BLUE CHIP IT INDUSTRY IN INDIA & JAPAN"

Ms. Sujata Kolekar
Sr. Director (Delivery Executive)
Capgemini

Date-06th July 2021
Time- 11.30am-12.30pm

Session will be conducted on Microsoft Teams

Note: Joining link will be shared with the students separately.

Follow us at : zealinstitutes

The institution sensitizes the students and the employees to the constitutional obligations about values, rights, duties and responsibilities and constantly works upon to nurture them as better citizens of the country through various curricular and extra-curricular activities.



**ZEAL EDUCATION SOCIETY'S
ZEAL COLLEGE OF ENGINEERING AND RESEARCH
NARHE | PUNE -41 | INDIA**



ZEAL INSTITUTES
www.zealindia.com
NARHE | PUNE | INDIA

RANAANGAN
2022

SPORTS TOURNAMENT

ENGINEERING & MANAGEMENT INSTITUTES

Date : 03rd April 2022 to 6th April 2022

Prize Distribution Ceremony : 13th April 2022

INDOOR GAMES

 Chess Prof. Sanjivini Jeshi 875970310	 Carrom Prof. Anuja Galande 9970420827	 Table Tennis Prof. Prachiti Shinde 9404926149
--	--	--

OUTDOOR GAMES

 Cricket Mr. Dnyaneshwar Kamble 778719291	 Basketball Prof. Zinje S. M. 83297813568	 Football Prof. Shashikant Galande 8275144437	 Volleyball Prof. Jayram Gurav 9628696554	 Kabaddi Prof. Vilas Patil 92706975466
 Running Prof. Ankur Patil 7828204822	 Kho-Kho Prof. Jayesh Sarvade 9840834182	 Shot Put Prof. Pravin Patil 992213748	 Tug of War Prof. Ganesha Kadam 882871164	 Throw Ball Prof. Umash Salkal 746699223

Institute Sports Coordinator : Prof. Ranjit Zende : 9763030081, Dr. Pramod Magade : 9709488019

Mr. Sumit Nikam Central Level Sports Coordinator 9130777008	Mr. Nikhil Patil Basketball Coach 9545705045	Mr. Satish Ajmerkar Football Coach 8793321366	Mr. Ketan Shinde Volleyball Coach 8830205613
--	---	--	---



**ZEAL EDUCATION SOCIETY'S
ZEAL COLLEGE OF ENGINEERING AND RESEARCH
NARHE | PUNE -41 | INDIA**



The college establishes policies that reflect core values. Code of conduct is prepared for students and staff and everyone should obey the conduct rules. The institution encourages participation of students in Sports and Games, NCC and NSS at National level to strengthen nationwide bond and relation.

The institution takes many initiatives like conducting awareness campaigns, organizing orientation & training program, seminars and workshops to sensitize the future leaders to inherit human values coping with the constitutional obligations. Ethical Values, rights, duties and responsibilities of citizens are some of the topics which are enlisted in Elocution/ Debates activities.



ZEAL
INSTITUTES
www.zealeducation.com
NARHE | PUNE | INDIA



**ZEAL COLLEGE OF ENGINEERING &
RESEARCH, PUNE**

Department of Electrical Engineering

Guest Lecture on

“WAY FORWARD TOWARDS CARBON NEUTRALITY”



29/09/2021

11:00 AM to 01:00 PM



**Session will be
conducted on
Microsoft Team.**

Link : bit.ly/3zStqF3



Dr. Om Prakash Kulkarni

**Scientist
MNRE**

Follow us at : [zealinstitutes](https://www.facebook.com/zealinstitutes)     



ZEAL
INSTITUTES
www.zealeducation.com
NARHE | PUNE | INDIA



ZEAL COLLEGE OF ENGINEERING & RESEARCH, PUNE

S. No.39, Narhe-Dhayari Road, Narhe Pune
www.zealeducation.com



**भिशन युवा
स्वास्थ्य**

महाविद्यालयीन विद्यार्थ्यांसाठी
मोफत कोविड-19 लसीकरण मोहीम

उच्च व तंत्र शिक्षण विभाग, महाराष्ट्र राज्य



श्री. उद्धव ठाकरे
मुख्यमंत्री, महाराष्ट्र राज्य



श्री. उदय सामंत
उच्च व तंत्र शिक्षण मंत्री, महाराष्ट्र राज्य

दिनांक : 30 ऑक्टोबर 2021

वेळ : सकाळी 10.00 ते सायंकाळी 05.00

स्थळ : सी. एस. एम. ए., झील नन्हे कॅम्पस, पुणे | संपर्क : श्री. अशोक जाधव - 8788399609



ZEAL
INSTITUTES
www.zealeducation.com
NARHE | PUNE | INDIA



ZEAL COLLEGE OF ENGINEERING & RESEARCH, PUNE

Department of Civil Engineering

GIS Excellence Center
CELEBRATING WORLD GIS DAY



Speaker

Dr. Bhaskar R. Nikam

Scientist/Engineer 'SF'
Water Resources Department Indian Institute of Remote Sensing Indian Space Research Organization, Department of Space | Govt. of India, 4, Kalidas Road, Dehradun.



Speaker

Prof. R. P. Kulkarni

GIS Expert
Symbiosis Institute of Technology

Webinar on
WATERSHED MANAGEMENT
USING REMOTE SENSING AND GIS

Webinar on
THE APPLICATIONS OF GIS FOR
WATER RESOURCE MANAGEMENT :
AN OPEN SOURCE APPROACH



17/11/2021
9.30 AM onwards

Session will be conducted on
Microsoft Team

Vision

To contribute in the field of Civil Engineering accentuating value added advanced technical knowledge, promoting research and prescient towards entrepreneurial skills.

Webinar on
**"LEARN JAPANESE - OPPORTUNITIES IN BLUE CHIP
IT INDUSTRY IN INDIA & JAPAN"**



Ms. Sujata Kolekar
Sr. Director (Delivery Executive)
Capgemini



Date-06th July 2021
Time- 11.30am-12.30pm

Session will be
conducted on
Microsoft Teams



Note: Joining link will be shared with the students separately.



ZEAL INSTITUTES

www.zealeducation.com
NARHE | PUNE | INDIA



YOU ARE INVITED TO

"Deeksharambh"

SE INDUCTION PROGRAM

2021-22

DEPARTMENT OF
ELECTRICAL
ENGINEERING

SATURDAY
AUGUST 21st
2021

Scan to Join



OR

Video call Link:
<https://qrgo.page.link/jQD7j>

Time

10:00 AM Onwards

VISION OF DEPARTMENT

To build students technologically and ethically strong to meet the advanced technological challenges for the benefit of society and engineering industries.

Prof.Sudhir Mane
HoD,Electrical

Dr.Ajit Kate
Principal,ZCOER,Pune

Follow us at : [zealinstitutes](#)     



ZEAL INSTITUTE

www.zealeducation.com

NARHE | PUNE | INDIA



JUNIOR COLLEGE | ITI | POLYTECHNIC | ENGINEERING | MBA | MCA | Ph.D

ZEAL COLLEGE OF ENGINEERING & RESEARCH, PUNE

Department of Computer Engineering



The **TRUE TEACHERS** are those who help us to **THINK** for ourselves

TEACHER'S DAY CELEBRATION

SE CLASSROOM MAESTRO

"Dive into the world of artificial intelligence and machine learning"

"Air painter project"

Student Coordinator

Shravan Gupta : 9689582000

Namrata Biramane:7447596594

TE CLASSROOM MAESTRO

"DS algoracing-showcase your coding and problem-solving skills"

"Exploring machine learning"

Student Coordinator

Aditya Bhamre : 9370797455

Nakshtra Garad : 99755245738

STUDENTS SPARKELS

VIRTUAL VOCAL



Student Coordinator

Aditya Bhamre : 9370797455

Rutuja Nigade : 9623889334

MEET-GEET



Student Coordinator

Namrata Biramane : 7447596594

Ekansh Khandekar : 7798792044

TECH-KALAKAR



Student Coordinator

Shravan Gupta : 9689582000

Sharvari Paithankar : 8530137815

TUNE-O-BOTICS



Student Coordinator

Suyash Kardile : 9689809660

Shoyab Sayyad : 7020316796

STAFF COORDINATOR

Prof. Pravin S. Patil
9922173748

Prof. Vidhya R Vasekar
9665278347

WARM REGARDS

Prof. Aparna V Mote
Head of Department

Dr. Ajit M Kate
Principal

VISION OF DEPARTMENT

To emerge as a department of repute in Computer Engineering which produces competent professionals and entrepreneurs to lead technical and betterment of mankind.





ZEAL
INSTITUTES
www.zealeducation.com
NARHE | PUNE | INDIA



JUNIOR COLLEGE | ITI | POLYTECHNIC | ENGINEERING | MBA | MCA | Ph.D

ZEAL COLLEGE OF ENGINEERING & RESEARCH, PUNE

Department of Mechanical Engineering

Teachers Day Celebration

Guru Vandana



ELOCUTION COMPETITION

Topic for elocution competition is
"Thanks for planting seeds of knowledge"



Student Coordinator
Harsh Alase: 8208110185

PHOTOGRAPHY

The photograph should depict the theme
"My Hometown my pride"



Student Coordinator
Ankur Raut : 7040979463

SOCIAL MEDIA POST

The post should depict the theme
"Best Teachers of my life"



Student Coordinator
Anish Rane : 7058305706

POSTER MAKING

The photograph should depict the theme
"Heroes in Covid pandemic"



Student Coordinator
Mayuri Bhoite : 9529303383

ESSAY WRITING

The essay should depict the theme
"Online or offline Education"



Student Coordinator
Anosh Fransis : 8817211966

Overall faculty Coordinator:

Prof. J. A. Deshmukh
9665789785

Prof. S. S. Borade
9028906207

Follow us at : zealinstitutes





CERTIFICATE

Zeal Education Society Pune (Maharashtra) India

Has been adjudicated for the Mass attempt
"Largest Human Flag of India &
Human Portrait of Architects of Swarajya"
in which more than 4000 students formed a
human portrait to pay tribute to the architects of the Swarajya
on 25 January 2020 at Narhe, Pune (Maharashtra) India

Adjudicator : Mr. Santosh Patil (WBR - India)
Issuing Date : 25th January 2020

S. Shukla

Santosh Shukla

Supreme Court Advocate
President



WORLD BOOK OF RECORDS LIMITED - UK
SILVER EDITION - 2020 www.worldbookofrecords.uk

WORLD BOOK OF RECORDS
OFFICIAL ATTEMPT
WORLD BOOK OF RECORDS LIMITED
© No. WBR/UC/2019/2020

*ATTEMPT CERTIFICATE IS EFFECTIVE FOR 30 DAYS



ZEAL EDUCATION SOCIETY'S

ZEAL COLLEGE OF ENGINEERING AND RESEARCH

(Formerly Dnyanganga College of Engineering and Research)

(Approved by AICTE, New Delhi and Affiliated to Savitribai Phule Pune University, Pune)

S. No. 39, Narhe, | PUNE - 411 041 | INDIA . Phone No. 020-6720 6000/104 Tele Fax. 020-6720 6101

E-mail: principal.zcoer@zealeducation.com, Website: www.zcoer.org

Hon. S. M. Katkar

B.A. (Hons), L.L.B.

FOUNDER DIRECTOR

Dr. A. M. Kate

M. E., Ph. D (Mech.)

PRINCIPAL

Ref. No. ZCOER/AD/19565/2018-19

Date : 12.09.2018

To,

The RTO Officer,

Regional Transport Office, Pune region,

Pune.

Subject: Permission to organize "Free PUC Check up Camp" on the occasion of Engineers Day & World Ozone Day under Clean Air Mission on 15th September 2018.

Dear Sir,

We are glad to inform you that, we are going to organize PUC testing on the occasion of Engineers Day on 15th Sept.2018, open for public, free of cost in Pasalkar Bridge, Sinhgad Road, Near Abhiruchi Mall,Pune.. We are organizing this activity for the awareness of common public towards World Ozone Day, (16th Sept., 2018).We are requesting you to grant the permission for putting following Particulars at Pasalkar Bridge, Sinhgad Road, Near Abhiruchi Mall,Pune.

1. Pandaol (10 ft X 12 ft)
2. Small sound system for anchoring during inaugural function
3. PUC vehicle

Venue: Pasalkar Bridge, Sinhgad Road, Near Abhiruchi Mall,Pune.

Thanking you.

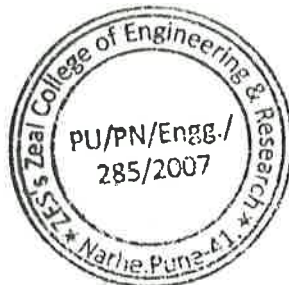

Dr. A. M. Kate
Principal
ZCOER,Pune.



Zeal Education Society's
Zeal College of Engineering & Research
Narhe , Pune-41 (Maharashtra)
Department of Mechanical Engineering

Ref. No.:

Date: 31/08/2018

To,
The Principal,
ZCOER, Pune.

Subject: Request to sanction the budget towards conduction of "Free PUC Check up Camp" on the occasion of Engineers Day & World Ozone Day under Clean Air Mission.

Respected Sir,

With reference to subject mentioned above, we are proposing Free PUC Check up Camp in the heart of Narhe near Nawale Bridge. This event is being conducted keeping in view the social awareness related to clean environment and wide publicity of our institute., We have invited RTO as chief guest of the inaugural function and waiting for his consent. However students have expressed their strong enthusiasm to conduct this event. The expected expenditure towards this program is as follows

Sr. No.	Particulars	Qty.	Rate per Unit	Amount in Rs.
1	PUC checking set up	01	6500.00	6500.00
2	Generator Back up	01	5000.00	5000.00
3	Covered Stage with Pandal (15' x 10' x 12')	01	20000.00	20000.00
4	Panel Caps with printing	100	50.00	5000.00
5	Bouquet	05	150.00	750.00
6	Stage Decoration	-	-	3000.00
Institute/ Event Advertisement				
7	College Stickers for Pasting on Vehicle	1000	2	2000.00
	Banners with Design (Size: 10' x 4')	02	10/ Per Sq. Ft.	800.00
	Banners with Design (Size: 6' x 3')	15	10/ Per Sq. Ft.	2700.00
	Banners with Design (Size: 10' x 6')	02	10/ Per Sq. Ft.	1200.00
8	Refreshment to Volunteers	100	20	2000.00
Total Amount in Rs.				48,950.00
In words: Forty eight thousand nine hundred and fifty only.				

So we hereby kindly request you to sanction the budget and issue the amount for successful conduction of the event.

Thanking you,

*Recommended
& for needed for approval
50% cost from MESA fund.
Hakate
31/08/2018*

Approved

*Allow
Jaiter*

Yours faithfully,

(Signature)
Dr.A.B.Ubale
H.O.D. (Mechanical Engg.)





Zeal Education Society's
Zeal College of Engineering & Research
Narhe , Pune-41 (Maharashtra)
Department of Mechanical Engineering

Ref. No.:

Date: 11.09.2018

OFFICE ORDER

Department of Mechanical Engineering is organizing the “Mega Free Pollution Check Up Camp” in association with Pune Traffic Police on occasion of “Engineers’ Day and World Ozone Day” on 15th September 2018 (9.00am to 5.00pm) at Pasalkar Bridge, Sinhgad Road, Near Abhiruchi Mall,Pune.

The following committees are constituted for the smooth functioning of the event. Faculty members are hereby informed to take note of it and act accordingly.

Sr. No.	Name of the Committee	Name of the coordinators
1	Flex Printing & Stage Arrangement	1. Prof. S. M. Godase 2. Prof. Kiran Bhoite 3. Prof. Lakhan Mali 4. Mr. Pravin Lendave 5. Mr. Netaji Thite
2	Inauguration	1. Prof. Sachin Borade 2. Prof. Mrs. Shalaka Joshi 3. Prof. Mrs. J.K.Tambe
3	Technical Committee	1. Prof. Tausif Shaikh 2. Prof. R.K.Petkar 3. Mr. Sanjay Karanjawane 4. Mr. Sushil Kamble 5. Mr. Swapnil Shewale 6. Mr. Pritam Vedpathak 7. Mr. Mayer Dimble
4	Photography, Media and Publicity	1. Prof. Pravin Parit 2. Prof. A. M. Kasar
5	Finance Committee	1. Prof. Junaid Deshmuk
6	Students coordination	1. Prof. Sujit Patil 2. Prof. P.S.Gadhav 3. Prof. H.P.Jagtap 4. Prof. Uday Gadpayle
7	Discipline committee	1. Prof. S. K. Mankanikar 2. Prof. Manoranjan Jadhav

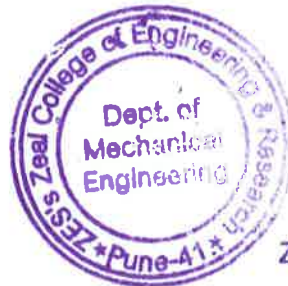

Dr.A.B.Ubale
H.O.D. (Mechanical Engg.)
Professor & Head
Dept. of Mech. Engineering
ZES's Zeal College of Engineering
& Research, Pune - 411 041.



ZEAL EDUCATION SOCIETY'S

ZEAL COLLEGE OF ENGINEERING AND RESEARCH

(Formerly Dnyanganga College of Engineering and Research)

(Approved by AICTE, New Delhi and Affiliated to Savitribai Phule Pune University, Pune)

S. No. 39, Narhe, | PUNE - 411 041 | INDIA . Phone No. 020-6720 6000/104 Tele Fax. 020-6720 6101

E-mail: principal.zcoer@zealeducation.com, Website: www.zcoer.org

Hon. S. M. Katkar
B.A. (Hons), L.L.B.
FOUNDER DIRECTOR

Dr. A. M. Kate
M. E., Ph. D (Mech.)
PRINCIPAL

Ref. No. ZCOER/AD/9566/2018-19

Date: 12.09.2018

To,

The RTO Officer,
Regional Transport Office, Pune region,
Pune

Subject: Invitation as Chief Guest for "Free PUC Check up Camp" on the occasion of Engineers Day & World Ozone Day under Clean Air Mission.

Dear Sir,

We are glad to inform you that, we are going to organize "Free PUC Check up Camp" on the occasion of Engineers Day and World Ozone Day on 15 Sept.2018, open for public, free of cost in Narhe, Pune. We are organizing this activity for the awareness of common public on occasion of World Ozone Day, (15th Sept., 2018) also. We would like to invite you as the chief guest for the inaugural function. Your gracious precious and guidance to the students and common public will be very helpful and appreciated.

You are requested to kindly accept our invitation and convey your availability for the function. Also, we would like to request you to provide a couple of traffic police for monitoring and help.

Venue: Pasalkar Bridge, Sinhgad Road, Near Abhiruchi Mall,Pune.

Time: 09.00 am

Thanking you.

Sincerely yours,

Am
13/9/2018.



“आयक विभाग”
प्रादेशिक परिवहन कार्यालय, पुणे.
आयक क्रमांक : 8159
दिनांक : 14.9.18
P. M. Kate
कनिष्ठ लिपिक
प्रा. प. कार्यालय, पुणे.

Am
Dr. A. M. Kate
Principal
ZCOER, Pune.



ZEAL EDUCATION SOCIETY'S

ZEAL COLLEGE OF ENGINEERING AND RESEARCH

(Formerly Dnyanganga College of Engineering and Research)

(Approved by AICTE, New Delhi and Affiliated to Savitribai Phule Pune University, Pune)

S. No. 39, Narhe, | PUNE - 411 041 | INDIA . Phone No. 020-6720 6000/104 Tele Fax. 020-6720 6101

E-mail: principal.zcoer@zealeducation.com, Website: www.zcoer.org

Hon. S. M. Katkar

B.A. (Hons), L.L.B.

FOUNDER DIRECTOR

Dr. A. M. Kate

M. E., Ph. D (Mech.)

PRINCIPAL

Ref. No. ZCOER/AD/ 9566/2018-19

Date: 12.09.2018

To,

Mrs. Tejaswi Satpute

Deputy Commissioner of Police
Pune.

Subject: Invitation as Chief Guest for inaugural function of "Free Mega PUC Check up Camp" on the occasion of Engineers Day & World Ozone Day under Clean Air Mission.

Dear Madam,

We are glad to inform you that, we have organized "Free Mega PUC Check up Camp" on the occasion of **Engineers Day and World Ozone Day on 15 Sept.2018**. We are organizing this activity for the awareness of ozone depletion on occasion of World Ozone Day.

We would like to invite you as the chief guest for the inaugural function of "Free Mega PUC Check up Camp". Your gracious precious and guidance to the students and common public will be very helpful and appreciated.

You hereby kindly request you to accept our invitation and convey your availability for the function.

Venue: Pasalkar Bridge, Sinhgad Road, Near Abhiruchi Mall,Pune.

Day & Date: Saturday & 15th Sept. 2018

Time: 09.00 am

Thanking you.

Sincerely yours,



A. M. Kate

Dr. A. M. Kate

Principal
ZCOER,Pune.

5/14/18
RECEIVED
Traffic Control Br.
Pune City

S. M. Katkar
B.A. (Hons), L.L.B.
FOUNDER DIRECTOR



ZEAL EDUCATION SOCIETY

Regd. No. MAH/11146/96/PUNE, Dt. 25-3-96 & F-12037 (Pune) Dt. 18-5-96
S. No. 25/3/3, Hingane Khurd, Sinhgad Road, Pune - 411 051
☎ : 020- 2434 8071 • Tele Fax : (020) 2434 5365
E-mail : zeal@zealeducation.com • website : www.zealeducation.com

Ref : ZES /

Date : 14/09/2018

INVITATION

झील एजुकेशन सोसायटी व ट्रॅफिक पोलीस पुणे यांच्या संयुक्त विद्यमाने फ्री मेगा "पी यु सी कॅम्प"

झील एजुकेशन सोसायटी व ट्रॅफिक पोलीस पुणे यांच्या संयुक्त विद्यमाने फ्री मेगा "पी यु सी कॅम्प" १५ सप्टेंबर २०१८ रोजी पासलकर ब्रीज, सिंहगड रोड, अभिरुची मॉल जवळ सकाळी ९.०० ते संध्याकाळी ५.०० या वेळेत आयोजित करण्यात येत आहे. "वर्ल्ड ओझोन डे" व "इंजिनियर्स डे" यांचे ओचित्य साधून या मोफत "पी यु सी कॅम्प" चे आयोजन करण्यात आले आहे. "पी यु सी कॅम्प" चा मुख्य उद्देश वाहनचालकाने मध्ये पर्यावरण सुरक्षा व पर्यावरण संरक्षणसंबंधी जनजागृती करणे हा आहे. या कॅम्प मध्ये वाहनांची तपासणी झाल्यानंतर वाहनचालकांना "पी यु सी" सर्टिफिकेट्स देण्यात येणार आहे. या कार्यक्रमास श्री बाबासाहेब आझरी (आर टी ओ पुणे), तेजस्वी सातपुते (डीएसपी, ट्रॅफिक पुणे), श्री जयेश काटकर (कार्यकारी संचालक, झील एजुकेशन सोसायटी, पुणे) आणि डॉ. संजय देवकर (संकुल संचालक, झील एजुकेशन सोसायटी, पुणे) हे उपस्थित असणार आहेत.

तरी आपण या मोफत "पी यु सी कॅम्प" बदलची माहिती आपल्या दैनिकात प्रसिद्ध करावी व या सामाजिक कार्यात सहभाग नोंदवावा. तसेच आपण या कॅम्पला भेट द्यावी हि नम्र विनंती.

आपला,

Riswkeysh
डॉ. विश्वेश काकांडीकर,

जनसंपर्क अधिकारी,

झील एजुकेशन सोसायटी नर्हें, पुणे

मो.नं. 7028085581





i Zeal Education Society's
Zeal College of Engineering & Research
Narhe , Pune-41 (Maharashtra)
Department of Mechanical Engineering

Ref. No.: ZCOER/MECH/2018-19/234

Date: 3/09/2018

To,
The Principal,
ZCOER, Pune.

Subject: Regarding re-calibration of PUC Unit (4 Gas Analyzer).

Respected Sir,

With reference to subject mentioned above, we are planning to conduct the mega PUC Checking of Two wheeler at our college as a social activity. The budget regarding this activity has been already submitted to Institute. For this activity we are planning to use our departmental PUC Checking unit (4 Gas Analyzer).

The calibration period of the said unit is expired on 26-1-2018. After calibration, we can use the above said unit for issuing PUC certificate. In order to carry out the re-calibration we wish to spend expenses through our departmental MESA fund. The tentative expenditure towards the same is Rs.7080/- incl.18% GST as per communication with **Sohamm Calibration Services, Kalewadi, Pune.**

So, we hereby kindly request you to permit us to carry out the re-calibration of PUC measuring instrument.

Thanking you,

Yours faithfully,

Dr.A.B.Ubale
H.O.D. (Mechanical Engg.)

*Permitted
A. Ubale
03/09/18*



Zeal Education Society's
Zeal College of Engineering & Research
Narhe, Pune-41 (Maharashtra)
Department of Mechanical Engineering

Ref. No.:

Date: 31/08/2018

To,
The Principal,
ZCOER, Pune.

Subject: Request to sanction the budget towards conduction of "Free PUC Check up Camp" on the occasion of Engineers Day & World Ozone Day under Clean Air Mission.

Respected Sir,

With reference to subject mentioned above, we are proposing Free PUC Check up Camp in the heart of Narhe near Nawale Bridge. This event is being conducted keeping in view the social awareness related to clean environment and wide publicity of our institute., We have invited RTO as chief guest of the inaugural function and waiting for his consent. However students have expressed their strong enthusiasm to conduct this event. The expected expenditure towards this program is as follows

Sr. No.	Particulars	Qty.	Rate per Unit	Amount in Rs.
1	PUC checking set up	01	6500.00	6500.00
2	Generator Back up	01	5000.00	5000.00
3	Covered Stage with Pandal (15' x 10' x 12')	01	20000.00	20000.00
4	Panel Caps with printing	100	50.00	5000.00
5	Bouquet	05	150.00	750.00
6	Stage Decoration	-	-	3000.00
Institute/ Event Advertisement				
7	College Stickers for Pasting on Vehicle	1000	2	2000.00
	Banners with Design (Size: 10' x 4')	02	10/ Per Sq. Ft.	800.00
	Banners with Design (Size: 6' x 3')	15	10/ Per Sq. Ft.	2700.00
	Banners with Design (Size: 10' x 6')	02	10/ Per Sq. Ft.	1200.00
8	Refreshment to Volunteers	100	20	2000.00
Total Amount in Rs.				48,950.00
In words: Forty eight thousand nine hundred and fifty only.				

So we hereby kindly request you to sanction the budget and issue the amount for successful conduction of the event.

Thanking you,

Yours faithfully,

*Recommended
& Permitted for approval
50% cost from MESA Fund.
[Signature]
21/08/2018*

[Signature]
Approved

Dr.A.B.Ubale
H.O.D. (Mechanical Engg.)

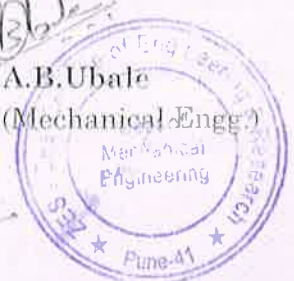

यूनियन बैंक
of India
Union Bank

गारु अंबेगाव शाखा, गारु अंबेगाव, पुणे, महाराष्ट्र
Narhe Ambegaon Branch, Narhe Ambegaon, Pune
Maharashtra
IFS Code : URIN0560901

दिनांक
Date

D	0	3	0	9	2	0	1	8
D	D	M	M	Y	Y	Y	Y	Y

Valid for 3 months from the date of issue

Pay **Sohamm Calibration Service**

या धारक को Or Bearer

नगरे Rupees **Seven thousand and eighty only**

अदा करें।

₹ 7080/-

खाता नं.
Ac No. **609002010000836**

चेक नं.
Cheque No. **33138950**

भारत की स्वामी सभी शाखाओं में सम्पूर्ण पर देय
PAYABLE AT PAR AT ALL OUR BRANCHES IN INDIA

MECHANICAL ENGINEERING STUDENT ASSOCIATION

Please sign above

⑈ 138950⑈ 411026043⑈ 609033⑈ 31

of India

[विशेष-मो. वा. ४० म.]

मोटर वाहन विभाग

1/6

मूळ प्रत

पावती नं.

5285915/104/1

दिनांक 05/09/18

खाली नमूद केलेल्या कारणाकरिता रुमचे

Renaval of 200 मिळाले.
Bulhorani

कर

भारतीय मोटर वाहन
अधिनियमाखालील फी

फी व इतर
जमा

रक्कम

रक्कम

रक्कम

2000 MH12/323/2013

मोटर वाहन क्रमांक

मोटर चालन अनुज्ञप्ति क्रमांक

रोखपालाची सही

नोंदणी प्राधिकारी

मोटर मालकांच्या माहितीकरिता सूचना

- नोंदणी प्राधिकाऱ्याच्या प्रतिरूप शिक्क्यासह रोखपालाने सही केल्याशिवाय कर भरल्याची कोणतीही पावती विधिग्राह्य मानली जाणार नाही.
- धनादेशाच्या रुपाने रक्कम भरली असेल तेव्हा बँकेमध्ये धनादेश वटवला गेला तरच पावती विधिग्राह्य ठरते. बँकेमध्ये धनादेश वटवला गेला नाही, तर नोंदणीकृत मालकांस त्याबाबत नियमानुसार विहित केलेला दंड भरावा लागेल. नोंदणी प्रमाणपत्र व विधिग्राह्य करमुद्रा यासारखी कागदपत्रे धनादेश वटवल्यानंतरच दिली जातील.
- कृपया आपली पावती नीट तपासून पहावी आणि त्यातील तपशीलाबाबत काही शंका असल्यास किंवा त्यात काही विसंगती असेल तर ती त्वरित नोंदणी प्राधिकाऱ्यांच्या निदर्शनास आणावी.





MESA

Free PUC check up camp

Department of Mechanical Engineering in association with Mechanical Engineering student Association & SAE India chapter Students conducted "Free PUC check up camp on the occasion of Engineers Day & World Ozone Day under Clean Air Mission on 15th September 2018. Detailed report attached herewith.

GALLERY



Free PUC check up camp Pandal at Bhumkar Square, Sinhgad road, Pune

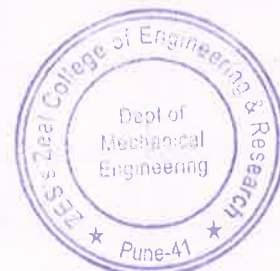

MESA



Opening ceremony "Free PUC check up camp"



Free PUC check up camp: PUC checking





MESA

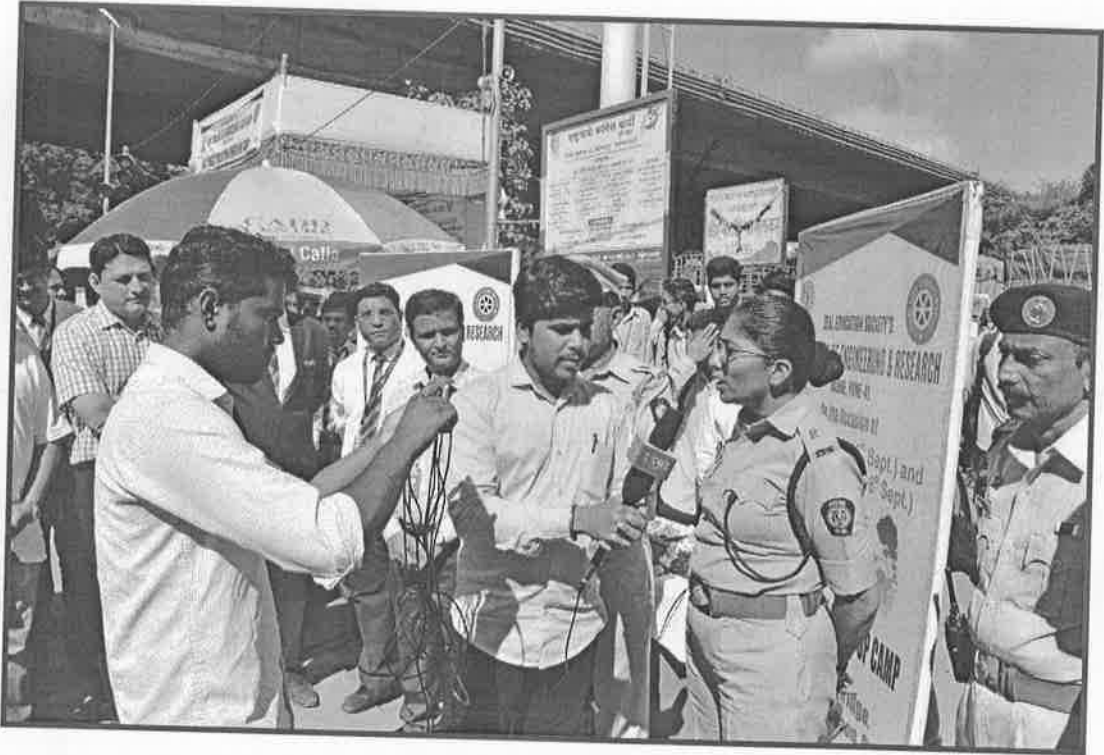

Free PUC check up camp: Media Coverage



वाहनांची मोफत प्रदूषण चाचणी

अभियंता दिन : हजारपेक्षा अधिक पीयूसीवाटप

लोकमत न्यूज नेटवर्क

पुणे : प्रादेशिक परिवहन कार्यालय, शहर पोलीस वाहतूक विभाग आणि नव्हे येथील इग्रील एज्युकेशन सोसायटीच्या इग्रील कॉलेज ऑफ इंजिनिअरिंगमधील मेकॅनिकल स्टुडन्ट असोसिएशनतर्फे जागतिक ओझोन व अभियंतादिनानिमित्त मोफत पीयूसी तपासणी आयोजिण्यात आला होती.

यावेळी वाहतूक पोलीस उपायुक्त तेजस्वी सातपुते, उपप्रादेशिक परिवहन अधिकारी संजय राजूत, सहायक विभागीय परिवहन अधिकारी आशिष पराशर, संदेश पाटील, सिंगगड रोड वाहतूक विभागाचे पोलीस उपनिरीक्षक सुबराय



मोफत पीयूसी तपासणी शिबिरप्रसंगी अधिकारी व प्राध्यापकवृंद.

लाड आणि इग्रील एज्युकेशन सोसायटीचे नव्हे संकुल संचालक डॉ. संजय देवकर उपस्थित होते. यावेळी प्रा. जयेश काटकर, डॉ. संजय देवकर, प्राचार्य अजित काटे यांच्या मार्गदर्शनाखाली या कार्यक्रमाचे

संयोजन डॉ. अमोल उयाळे, प्रा. आयुष तांबोळी, प्रा. गोडसे, प्रा. भोईटे, प्रा. माळी, प्रा. शोख, विद्यार्थी प्रतिनिधी रितेश गवळी यांनी केले. प्रा. सचिन घोराडे यांनी सूत्रसंचालन केले.





**ZEAL EDUCATION SOCIETY'S
ZEAL COLLEGE OF ENGINEERING AND RESEARCH
NARHE | PUNE -41 | INDIA**



To,
The Principal,
ZCOER, Narhe.

Subject: - Submission of One page report

Respected Sir,

Batmobile is regarded as the ultimate superhero car in the DC Comics Universe. The indestructible Batmobile has featured in many movies and with every new movie, the vehicle only becomes more aggressive looking. Batmobile is a fantasy thing just like the superheroes but there are many who would love to experience the life of a superhero! There are many replica Batmobiles around the world. In India, a group of students have made a replica of the latest Batmobile and it looks insane!

The project is funded by the college and is made from scratch by a group of students. The Batmobile looks quite realistic in the videos and it gets all the bling on the outside too. Talking about the vehicle itself, everything has been made by the in-house team including the roll cage of the vehicle. To start with, the students first made a scale model of the Batmobile, which was used as a reference to make the life-size model of the Batmobile. The project took around 50 days to complete, which is a very short time for such a project. The total cost? According to the video, it took only Rs 3.58 lakhs for the whole project.

Regards,

Dr.A.B.Ubale

HOD Mechanical Engineering

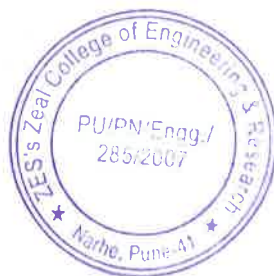

Zeal College of engineering and Research Narhe, Pune, institute has maintained high standards of effective teaching learning and self development of students. For application of the theoretical knowledge to practical world

When it comes to sustained growth, innovation is key and, in this endeavour, new products are designed and developed by industries as per the evolving market needs. Small business and large enterprise invest time, effort, resources, and a substantial amount of money to design, manufacture, and assemble electronics and other types of new-age industrial products that are optimized for functioning even in harsh environments.

New product designing includes system components design, assembly of the product, checking of the individual components, final assembly and testing. The process of product design involves activities such as deciding on the mechanical architecture, selecting materials and processes that meet the environmental requirements, engineering the various components that are necessary to make the product work, and finalizing the look and feel of the product.

Development, on the other hand, involves identifying new opportunities in the market and building products that appeal to the needs of the selected market. The focus of a product design and development process lies in refining or modifying the products to a final prototype and testing.

Developing new products is an involved task. It is not only time-consuming and costly but a huge risk to investment if the right resources are not involved. Hence, it is crucial to involve experts with proficient technical skills who have rich experience in product design and development. The leadership of the product development companies and teams should have prior experience in strategy formulation and implementation in product commercialization.

With the help of product development companies that render such spec to product engineering services, dynamic products can be designed with efficiency and ease. They can also assist with the evolution of the mission-critical designs by conducting in-depth research, and by putting in the hours required for the engineering, prototyping, modifying, or re-testing of the product.

User-centric design and effective development using state of the art technology encourage customers to see the true benefit and value of the products. The quality and performance of your products can significantly help your business to perform to its optimal best and gain an edge over competitors.

Based on the above grounds and the enthusiasm of the students together decided that we will make something innovative and challenging task. By keeping in view we find the batmobile tumbler car which is not only a complex in designing but manufacturing is also very difficult based on the existing resources available in and near to the Pune.

Nothing was available when a team of students, staff and Faculty members were started the execution this project. Based on a toy car every minute details of external panels were designed. After a lot market survey based on the market survey the engine is finalized as Mahindra Xylo engine with 2498 cc and its hub are finalized as wheel hub.



One by one all chassis members are designed and manufactured, engine , transmission line and wheels are assembled and then started the design and manufacturing the body panel. Before the final assembly non coated panels were mounted on the vehicle and testing was done. Once the testing is completed satisfactorily panels were powder coated and final assembly is done. The inauguration of the vehicle is done on 3 July 2019. The project was started on 21 April 2019.

Till today vehicle is kept for demonstration at various placed and more than 100K views are present in an online and off line mode.





Student preparing and manufacturing model

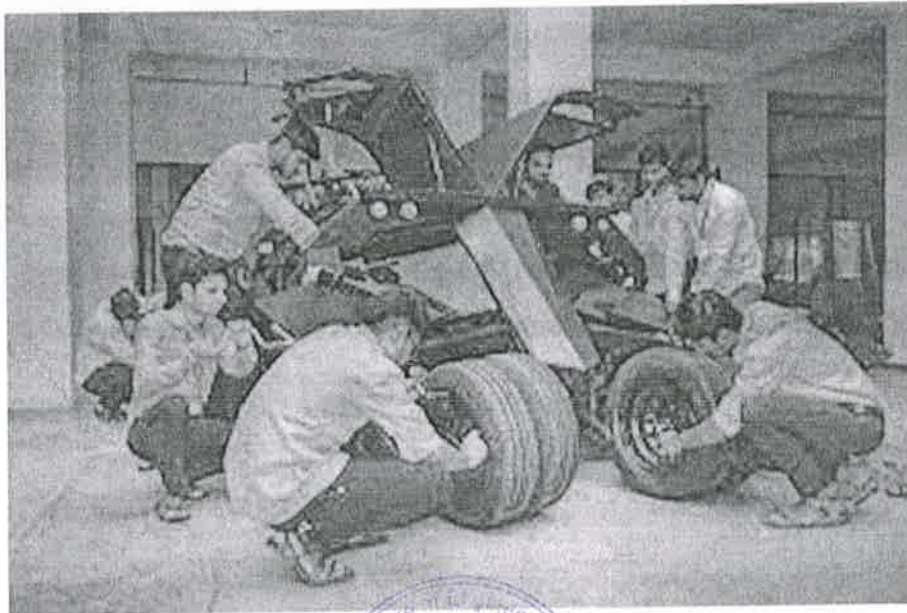

Student preparing and manufacturing model





Media Coverage

Video Link:

<https://www.youtube.com/watch?v=hMuFhyf7rSE>

<https://www.youtube.com/watch?v=Bkfm8ZwYie8>

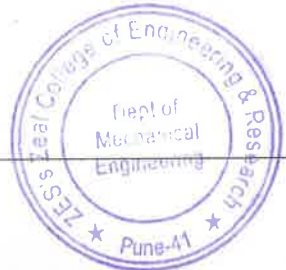

माझा महाराष्ट्र

झील एज्युकेशन सोसायटीच्या विद्यार्थ्यांचा प्रयोग
पुण्यातील चार विद्यार्थ्यांनी तयार केली
देशातील पहिली हॅंडमेड बॅटमोबिल कार

छविनिर्माता: पु.प.

पुण्यातील झील एज्युकेशन सोसायटीच्या विद्यार्थ्यांनी तयार केलेली बॅटमोबिल कार. ही कार देशातील पहिली हॅंडमेड बॅटमोबिल कार आहे. ती पुण्यातील झील एज्युकेशन सोसायटीच्या विद्यार्थ्यांनी तयार केली आहे. ही कार देशातील पहिली हॅंडमेड बॅटमोबिल कार आहे.



राष्ट्रीय झील एज्युकेशन सोसायटीच्या विद्यार्थ्यांनी तयार केलेली बॅटमोबिल कार.

पुण्यातील झील एज्युकेशन सोसायटीच्या विद्यार्थ्यांनी तयार केलेली बॅटमोबिल कार. ही कार देशातील पहिली हॅंडमेड बॅटमोबिल कार आहे. ती पुण्यातील झील एज्युकेशन सोसायटीच्या विद्यार्थ्यांनी तयार केली आहे.

झील एज्युकेशन सोसायटीच्या विद्यार्थ्यांनी तयार केलेली बॅटमोबिल कार. ही कार देशातील पहिली हॅंडमेड बॅटमोबिल कार आहे. ती पुण्यातील झील एज्युकेशन सोसायटीच्या विद्यार्थ्यांनी तयार केली आहे.

झील एज्युकेशन सोसायटीच्या विद्यार्थ्यांनी तयार केलेली बॅटमोबिल कार. ही कार देशातील पहिली हॅंडमेड बॅटमोबिल कार आहे. ती पुण्यातील झील एज्युकेशन सोसायटीच्या विद्यार्थ्यांनी तयार केली आहे.

झील एज्युकेशन सोसायटीच्या विद्यार्थ्यांनी तयार केलेली बॅटमोबिल कार. ही कार देशातील पहिली हॅंडमेड बॅटमोबिल कार आहे. ती पुण्यातील झील एज्युकेशन सोसायटीच्या विद्यार्थ्यांनी तयार केली आहे.

htmetro

HINDUSTAN TIME'S PUNE
THURSDAY JULY 04 2009

PUNE IN
NUMBERS

5,864
More numbers delivered from the e-edition
Please check the date and page 5/2



shortstories



• Batmobile, designed by the mechanical engineering students of ZeeL College of Engineering and Research, on display at Navi path, on Wednesday. SOURCE: HINDUSTAN TIME'S

STYLE QUOTIENT OF PUNE STREETS
REVVED UP WITH A 'BATMOBILE'

PUNE: Mechanical engineering students of ZeeL College of Engineering and Research inaugurated their 'Batmobile' on Wednesday at Navi path. A team of four students under the guidance of faculty members designed and manufactured an off-road car resembling the Batmobile. It is a hand-made concept car derived from the super hero movie Batman. The car has been made by synthesizing 25 different vehicles' components. It is a 100 cc engine-powered 12-horsepower. Along with the team of four students, there was a supporting team of faculty and instructors who have contributed as well. Lead Designer, head of mechanical department of ZeeL College of Engineering and Research. The students who worked on this project are in their final year of mechanical engineering - Sudhesh Shinde, Anurag Kulkarni, Vivek Gaurav and Vedant Jagtap. Vivek Gaurav said, "This was a wish had theoretical knowledge but after working on this project, many new concepts and ideas emerged." The car, which seats two, has a 100 cc diesel engine. The estimate has applied for a patent for this car.

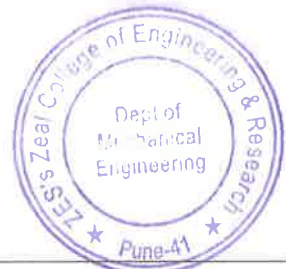

To,
The Principal,
ZCOER,
Narhe; Pune-41.

Date: 17/4/2019

(197)

Sub: Funding amount required for **UTV Car** project work.

Project Name: Design and development of **Batmobile Car (Tumbler)** for college.

Respected Sir,

As mentioned above subject faculties of Mechanical Department are going to design & develop **Batmobile Car (Tumbler)** for college. The detail expenditure for manufacturing of car is given below.

Sr. No	Description	Quantity	Approx Cost	Total
1	Old Car	1	1,00,000	1,00,000
2	Car maintenance and assembling		90000	90000
3	Chassis Material	200ft	120000	120000
4	Hub Manufacturing	2	20000	40000
5	Suspension	4	20000	80000
6	Fabrication Cost		80000	80000
7	Wheel and Tyres	4	25000	100000
8	Body work and painting		120000	120000
9	Tools and Consumables		20000	20000
10	miscellaneous		50000	50000
Total				8,00,000/-

Kindly sanction the amount **Rs-8,00,000/-** for same.

Thanking You.

Prof.P.A.Parit

Forwarded
to Prof. P. A. Parit

Dr.A.B.Übale

HOD Mech



Allow
J. K. Kulkarni

Dr.A.M.Kate

Principal ZCOER

Shr

Mr.P.V.Khandave

Executive Director ZES

M. P. V. Khandave
17/04/19

To,
The Principal,
ZCOER,
Narhe; Pune-41.

Date: 17/4/2019

Sub: Full time dedicated team required for **UTV Car** project work.
Project Name: Design and development of **Batmobile Car (Tumbler)** for college.

Respected Sir,

As mentioned above subject faculties of Mechanical Department are going to design & develop **Batmobile Car (Tumbler)** for college. As time given for completion of project is only one month (i.e.30/05/19). Considering this deadline we required fulltime staff for this project. List of staff is given below.

Sr. No	Name	Designation	Role in Project
1	Dr. Amol Ubale	HOD	Project Head & Guide
2	Prof. Pravin Parit	Assistant Professor	Design
3	Prof. Mahendra Kalyanshetti	Assistant Professor	CAD Design
4	Prof. Suhas Sawant	Assistant Professor	CAD Design
5	Prof. Sushil Kamble	Teaching Assistant	CAD Design
6	Mr.Pravin Lendve	Workshop Staff	Welder
7	Mr.Haridas Lendeve		Welder
8	Mr.Ghadge		Welder
9	Mr.Namdev Kumbhar	Peon	Helper
10	Mr.Ramdas Kadu	Peon	Helper

Kindly allow above staff for this project. .

Thanking You.

Prof.P.A.Parit

Forwarded to principal for consideration.

Dr.A.B.Ubale

HOD Mech



Dr.A.M.Kate

Principal ZCOER

Mr.P.V.Khandave

Executive Director ZES



ZEAL EDUCATION SOCIETY'S
ZEAL COLLEGE OF ENGINEERING AND RESEARCH,
NARHE | PUNE -41 | INDIA

DEPARTMENT OF MECHANICAL ENGINEERING

24/04/2019

Ref

To,

The Principal,

Zocer, Narhe, Pune.

Sub:- About getting permission to following students and staff for Batmobile project

Respected sir,

As per the discussion with you, we require following students and staff members to work on the bat mobile project work. So I request you to consider this and do the needful

Sr. No.	Name	Designation in team
1	Dr. Amol Ubale	Project coordinator
2	Prof. Parit Pravin	Team member and workshop incharge for project
3	Prof. kalyanshetty Mahendra	CAD Designer
4	Prof. Savant Suhas	Team member and purchase incharge
5	Mr. Lendave Pravin	Welder
6	Mr. Lendave Haridas	Welder
7	Mr. Kamble Sushil	CAD Designer
8	Atpalkar Ajinkya Nandkishor	Student members
9	Avhad Saurabh Shankar	Student members
10	Babar Shubham Pradeep	Student members
11	Kapil Gorakhanath Hajare	Student members
12	Koushik Sanjay More	Student members
13	Shind Shiddhesh Vinod	Student members
14	Sahil Gulamnabi Pinjari	Student members
15	Shubham Sandesh Rane	Student members

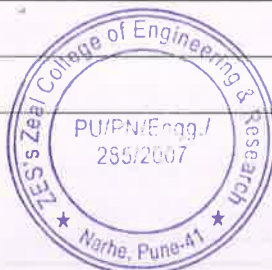



ZEAL EDUCATION SOCIETY'S
ZEAL COLLEGE OF ENGINEERING AND RESEARCH,
NARHE | PUNE -41 | INDIA

DEPARTMENT OF MECHANICAL ENGINEERING

16	Vishal Jagannath Raut	Student members
17	Sairaj Hanuman Sarode	Student members
18	Siddik Mahmadsalim Shaikh	Student members
19	Siddhesh Rajendra Shimpi	Student members
20	Vivek Prakash Tanpure	Student members

Approved By

Dr. Ajit Kate
Principal



Yours' sincerely

Dr. A. B. Ubale
Associate Proff. And Head Of Dept.
Mechanical Engineering Dept.

Zeal College of Engg. & Res. 2019-20

39, Narhe Village, Pune -411041

BAJA / Sufara ATV Vehicle

Ledger Account

1-Apr-2019 to 31-Jul-2019

Page 1

Date	Particulars	Vch Type	Vch No.	Debit	Credit
20-4-2019	Cr Metal Point BEING INV.NO.17765 RECD.FOR MS PIPE FOR BATMOBILE CAR - MECH.DEPT.	Journal	54	13,154.00	
29-4-2019	Cr Metal Point BEING INV.NO.17827 RECD.FOR MS SHEET FOR BATMOBILE CAR - MECH. DEPT.	Journal	72	6,331.00	
15-5-2019	Cr Abhyudaya Co-Op Bank 3398 ZCOER Payment Cheque 15-5-2019 89,990.00 Cr CHQ.NO. : 111959, BEING PAID AGNST. PUR.OF OLD XYLO CAR FOR BATMOBILE CAR PARTS (TUMBLER) - MECH.DEPT. TO CONCEPT MOTORS.		652	89,990.00	
21-5-2019	Cr Cash (Engineering College) BEING CASH PAID TO AMOL UBALE TOWARDS EXP INCURRED FOR DETAILS ENCLOSED. ZCOER/05/	Payment	695	69,441.00	
29-5-2019	Cr Metal Point BEING INV.NO.18039 RECD.FOR MS SHEET FOR <u>BATMOBILE CAR - MECH.</u> DEPT.	Journal	174	22,567.00	
12-6-2019	Cr Metal Point BEING INV.NO.18167 RECD.FOR MS ANGLE FOR <u>BATMOBILE CAR - MECH.</u> DEPT.	Journal	224	8,180.00	
13-6-2019	Cr Electro Power System BEING INV.NO.593 RECD.FOR EXITE BATTERY FOR BATMOBILE CAR (MECH.)	Journal	229	5,500.00	
19-6-2019	Cr Cash (Engineering College) BEING CASH PAID TO AMOL UBALE TOWARDS DETAIL BILLS ENCLOSED. ZCOER/06/	Payment	913	65,928.00	
24-6-2019	Cr Cash (Engineering College) BEING CASH PAID TO AMOL UBALE TOWARDS BATMOBILE CAR AS PER DETAILS ENCLOSED. ZCOER/06/	Payment	950	42,903.00	
				3,23,994.00	
Dr	Closing Balance				3,23,994.00
				3,23,994.00	3,23,994.00



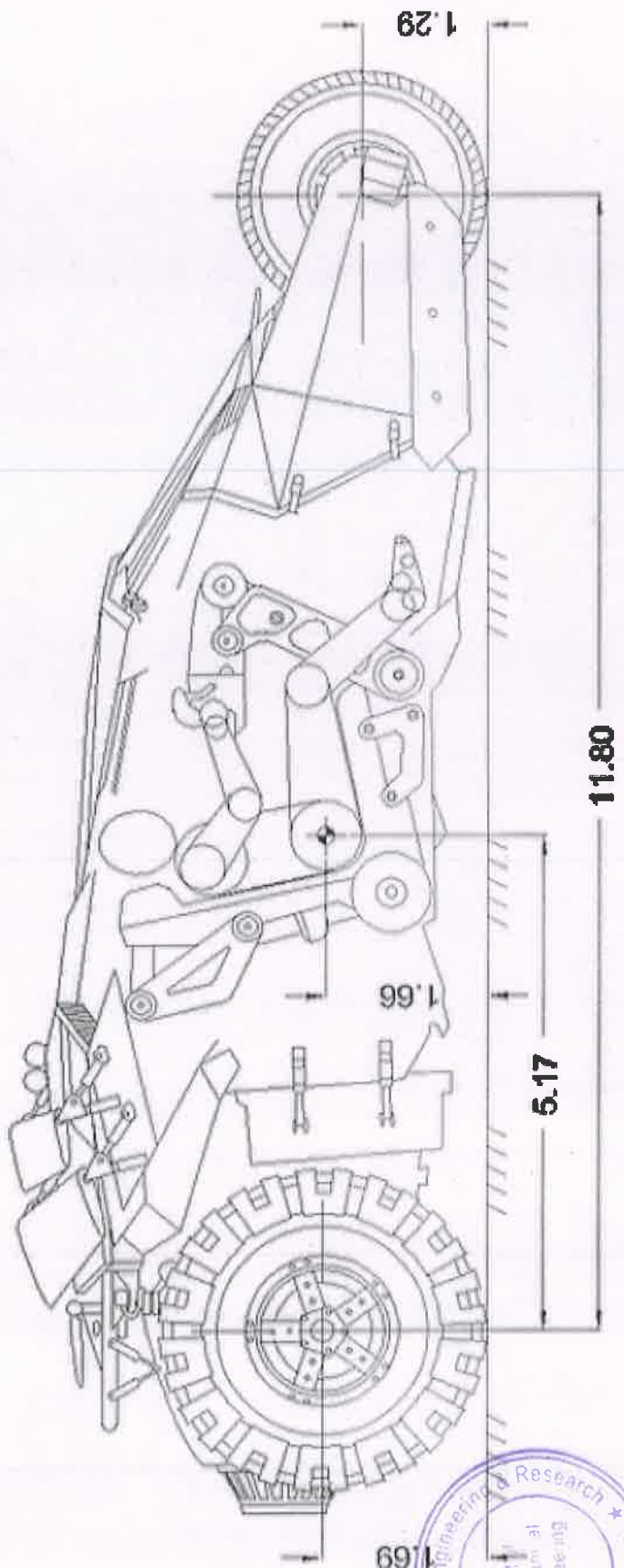
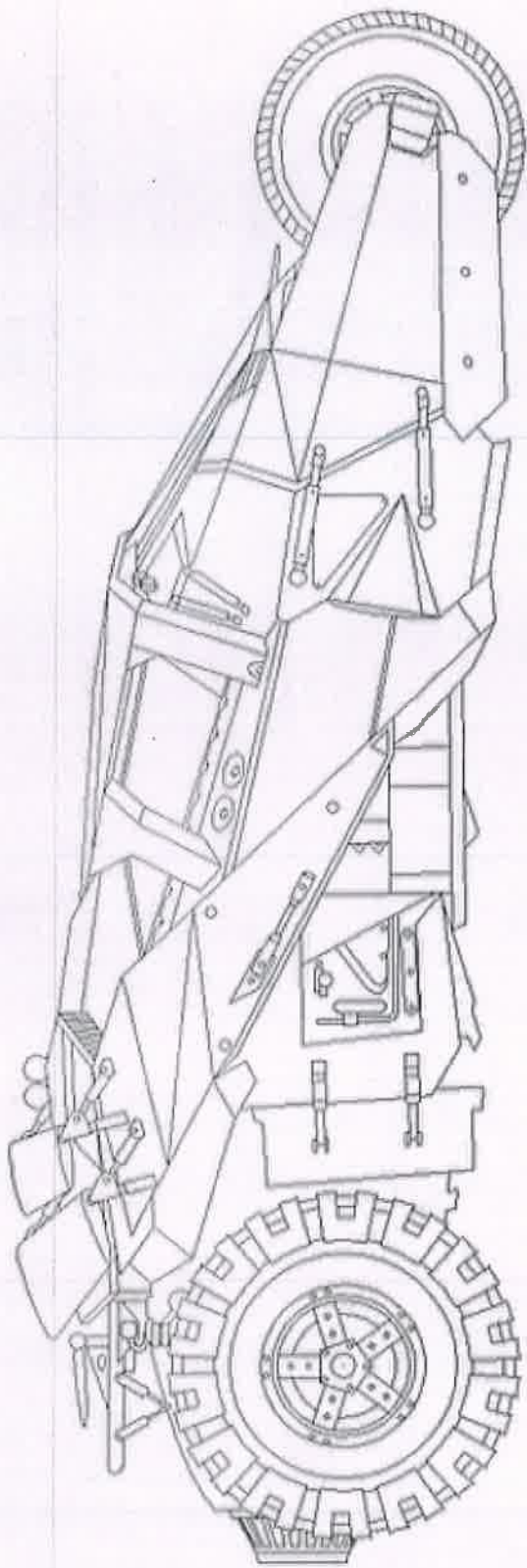

691



TITLE: TUMBLER

ASSIGNMENT: 9

UNITS: FEET

A

m

c

D

4

3

2

1

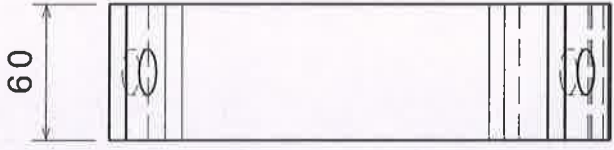

Left view
Scale: 1:3

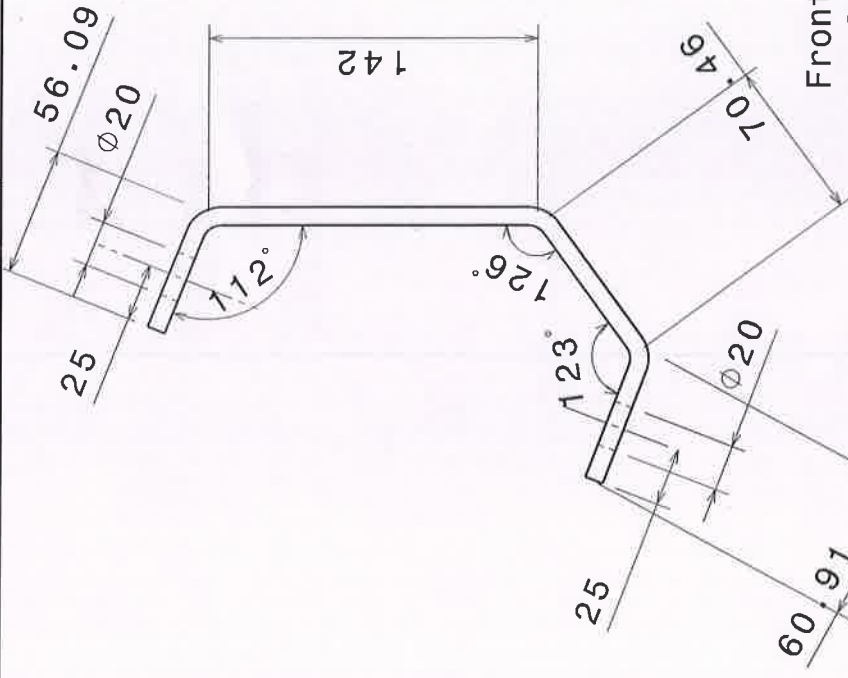

Front view
Scale: 1:3

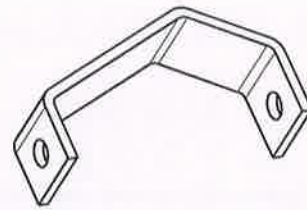

Isometric view
Scale: 1:5

bat-mobile

DESIGNED BY: admin	DATE: 5/14/2019	CHECKED BY: XXX	DATE: XXX	SIZE: A4	WEIGHT (kg): XXX	DRAWING NUMBER: XXX	SHEET: 1/1
<p>This drawing is our property; it can't be reproduced or communicated without our written agreement.</p>							

I
H
G
F
E
D
C
B
A

A

D



A B C D

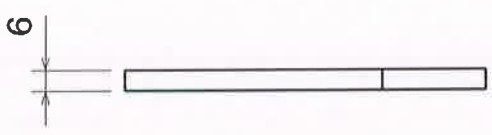

4 3 2 1

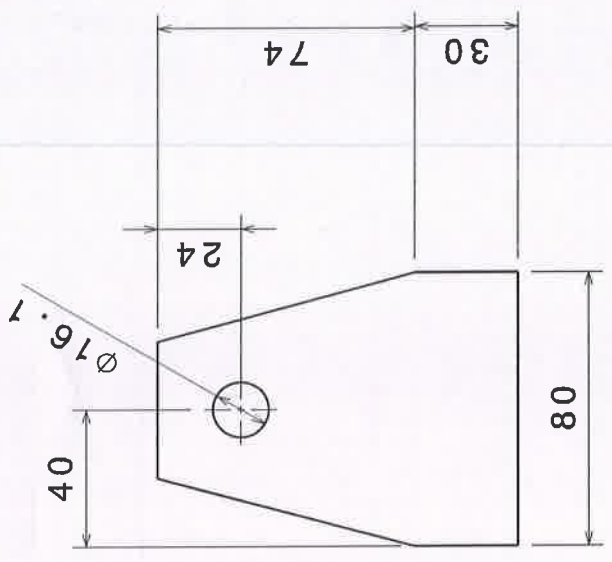

Front view
Scale: 1:2



Left view
Scale: 1:2

DESIGNED BY:	admin	Rear cross Mbr Support	
DATE:	5/18/2019	 	
CHECKED BY:	XXX		
DATE:	XXX		
SIZE	A4	BATMOBILE CAR	SHEET
SCALE	1:1	WEIGHT (kg)	1/1
This drawing is our property; it can't be reproduced or communicated without our written agreement.		Rear cross mbr support	



D A

A B C D

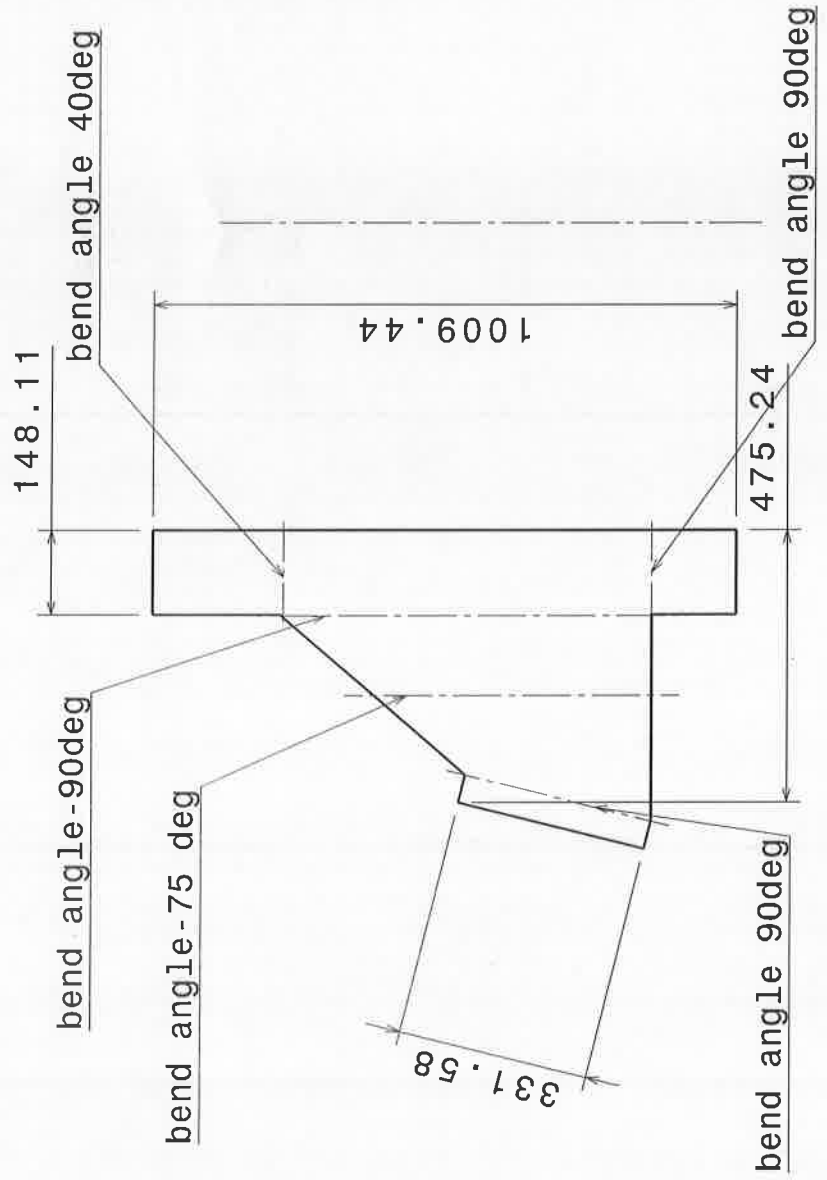

RH - Unfolded view

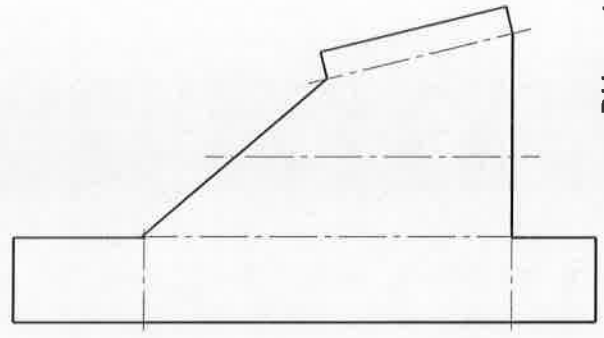

LH - - Unfolded view
Scale: 1:12

DESIGNED BY:	admin		DRAWING NUMBER	SHEET	I	-	
DATE:	6/4/2019				H	-	
CHECKED BY:	XXX				G	-	
DATE:	XXX	SIZE	A4	WEIGHT (kg)	XXX	F	-
SCALE	1:1	SCALE	1:1	XXX	E	-	
<p>LH - - Unfolded view Scale: 1:12</p>			<p>BATMOBILE</p>			D	-
<p>DESIGNED BY: admin</p>			<p>SIDE-2 bend panel</p>			C	-
<p>DATE: 6/4/2019</p>			<p>1:1</p>			B	-
<p>CHECKED BY: XXX</p>			<p>XXX</p>			A	-
<p>DATE: XXX</p>			<p>1/1</p>				



D A

This drawing is our property; it can't be reproduced or communicated without our written agreement.

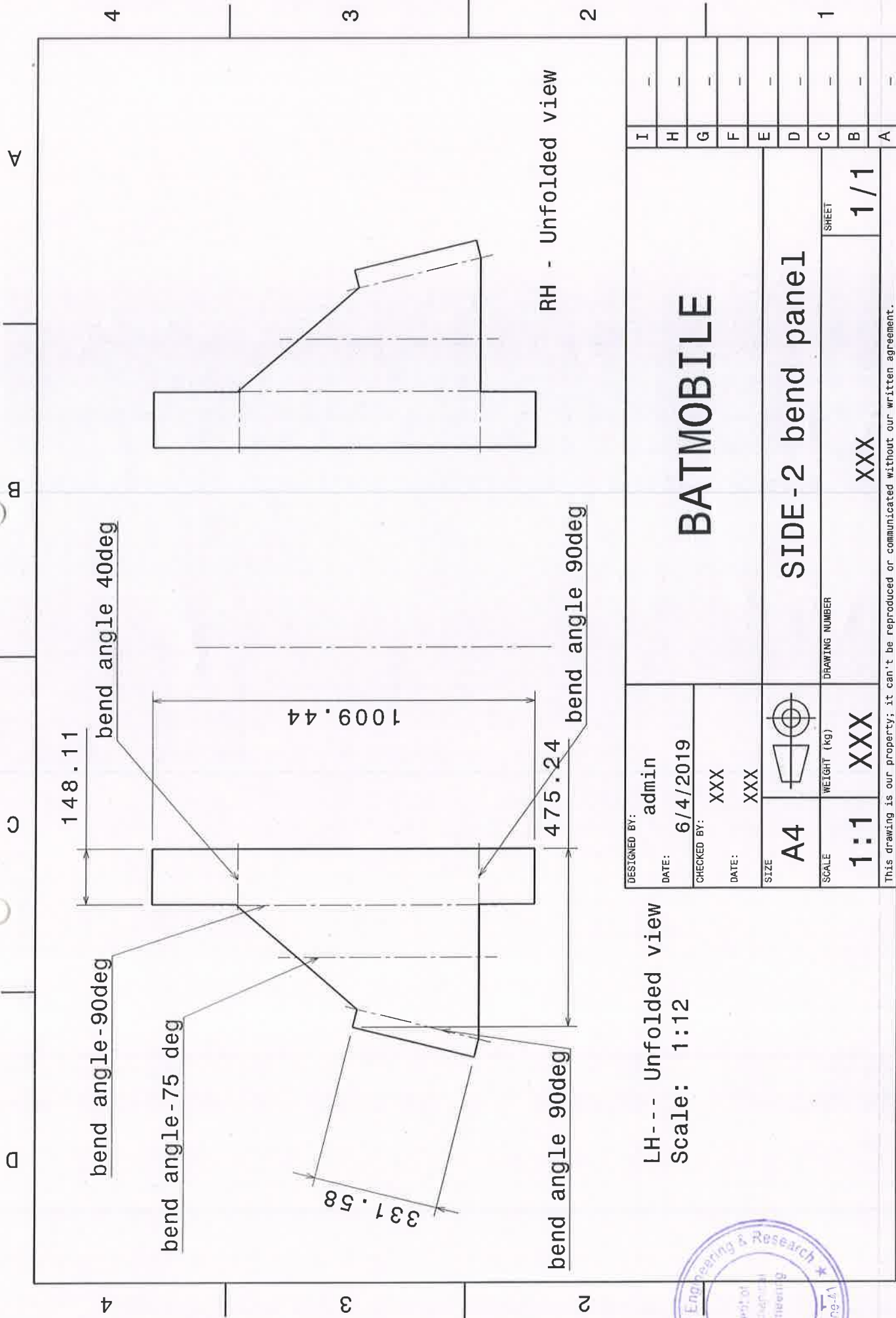

LH--- Unfolded view
 Scale: 1:12

RH - Unfolded view

DESIGNED BY:	admin
DATE:	6/4/2019
CHECKED BY:	XXX
DATE:	XXX
SIZE	A4
SCALE	1:1
WEIGHT (kg)	XXX
DRAWING NUMBER	XXX
SHEET	1/1

BATMOBILE

SIDE-2 bend panel

I	-
H	-
G	-
F	-
E	-
D	-
C	-
B	-
A	-



This drawing is our property; it can't be reproduced or communicated without our written agreement.

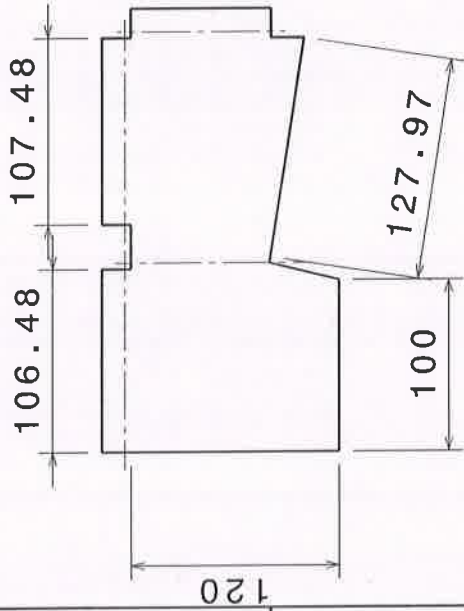

LH--Unfolded view
Scale: 1:4

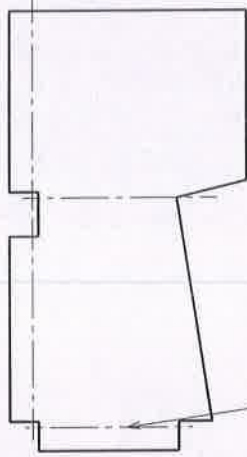

All bend angle 90 deg
RH--Unfolded view
Scale: 1:4

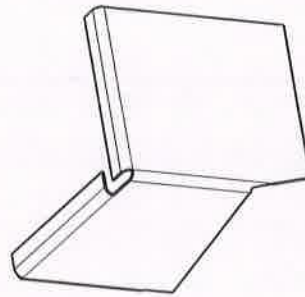

Isometric view
Scale: 1:4

DESIGNED BY: admin			SIZE A4	WEIGHT (kg) XXX	DRAWING NUMBER XXX	SHEET 1/1
DATE: 6/12/2019	CHECKED BY: XXX					
DATE: XXX	DATE: XXX					
This drawing is our property; it can't be reproduced or communicated without our written agreement.						

batmobile

front middle panel



A

B

C

D

4

3

2

1

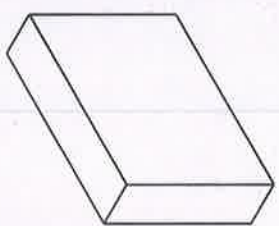

Isometric view
Scale: 1:1

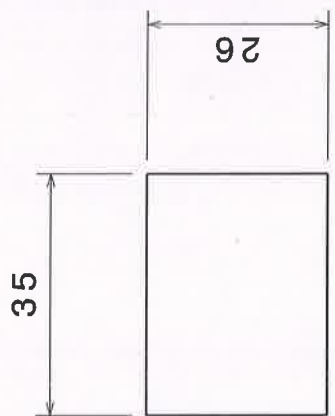

Front view
Scale: 1:1



Top view
Scale: 1:1

DESIGNED BY: admin			DRAWING NUMBER	SHEET				
DATE: 5/31/2019	CHECKED BY: XXX				XXX	1/1		
DATE: XXX	DATE: XXX							
SIZE: A4	SCALE: 1:1	WEIGHT (KG): XXX						
<h1>BATMOBILE</h1>		<h2>Support Block</h2>						
					<p>This drawing is our property; it can't be reproduced or communicated without our written agreement.</p>			
I	H	G	F	E	D	C	B	A



A

D

A

B

C

D

4

3

2

1

177.8

R5
Ø16

Ø16

Ø16

17.5

20

35

17.5

Front view
Scale: 1:3

20

355.6

Isometric view
Scale: 1:4

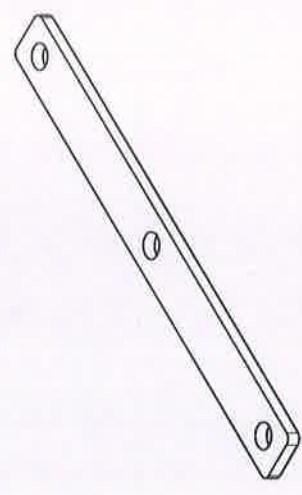

∞

Top view
Scale: 1:3

Qty: 2 no.

DESIGNED BY:	admin		DRAWING NUMBER	SHEET
DATE:	5/31/2019			
CHECKED BY:	XXX			
DATE:	XXX	WEIGHT (kg)	XXX	1/1
SIZE	A4	SCALE	1:1	XXX
BATMOBILE		Str_con_rod		
I		A		
H		B		
G		C		
F		D		
E		E		
D		F		
C		G		
B		H		
A		I		

This drawing is our property; it can't be reproduced or communicated without our written agreement.



A

D

4

3

2

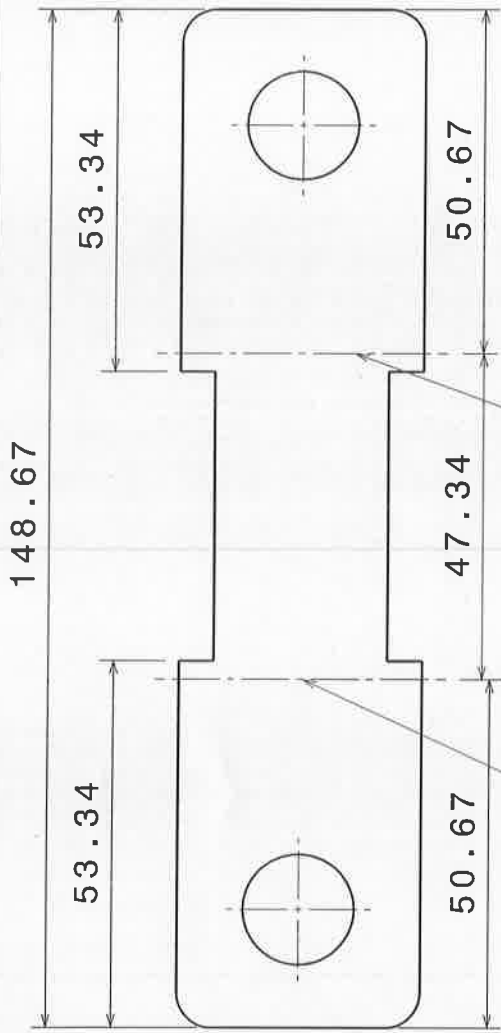
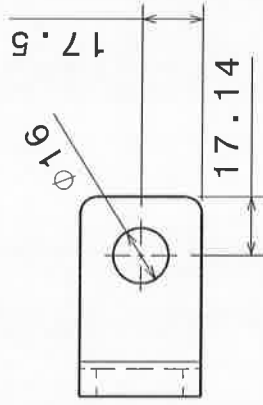
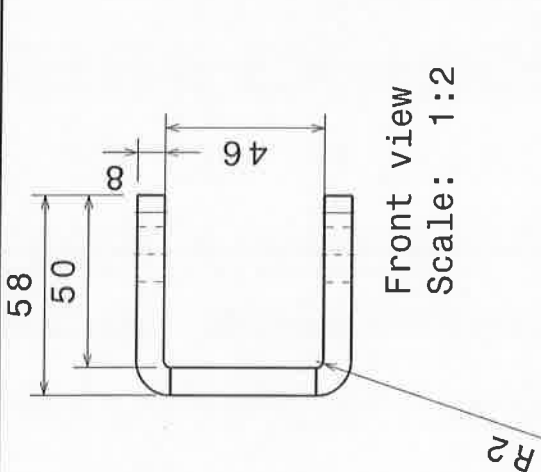

DESIGNED BY: admin	DATE: 5/31/2019		CHECKED BY: XXX		DATE: XXX		SIZE: A4		SCALE: 1:1		WEIGHT (kg): XXX		DRAWING NUMBER: C-Clamp_1		SHEET: 1/1	
BATMOBILE																
C-Clamp_1																
This drawing is our property; it can't be reproduced or communicated without our written agreement.																

D A

A

m

C

D

4

3

2

1

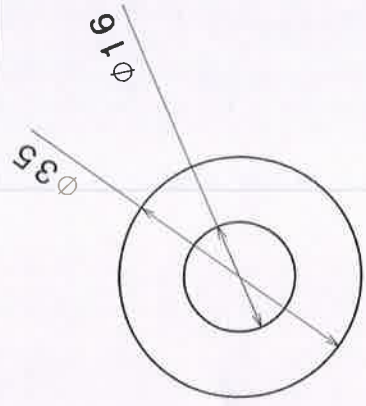

Front view
Scale: 1:1

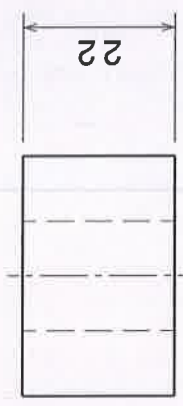

Top view
Scale: 1:1

BUSH

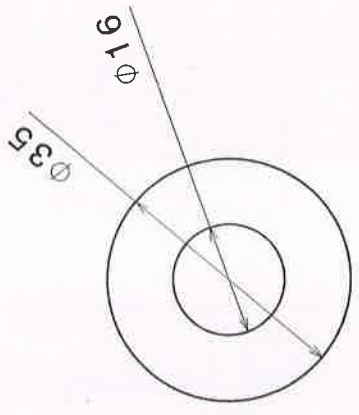

Front view
Scale: 1:1

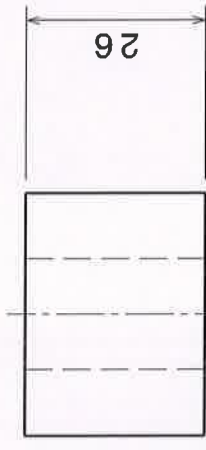

Top view
Scale: 1:1

BATMOBILE

BUSH Center



DESIGNED BY: admin	DATE: 5/31/2019			DRAWING NUMBER	SHEET
CHECKED BY: XXX	DATE: XXX				
SIZE: A4	SCALE: 1:1	WEIGHT (kg): XXX	XXX		
This drawing is our property; it can't be reproduced or communicated without our written agreement.					

I -
H -
G -
F -
E -
D -
C -
B -
A -

A

D

4 3 2 1

A B C D E F G H

4 3 2 1

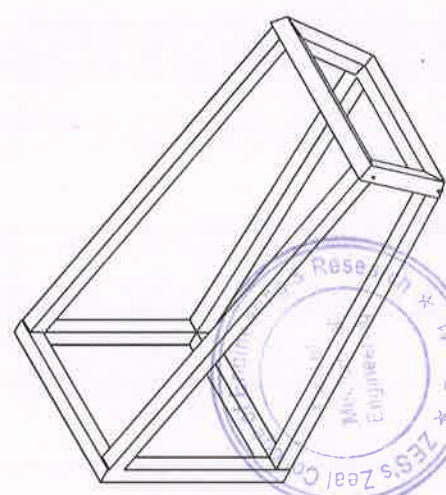
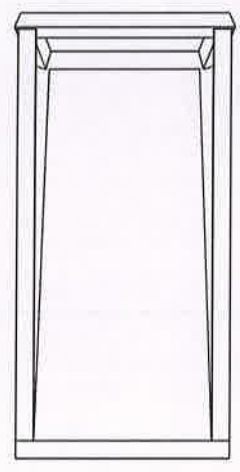
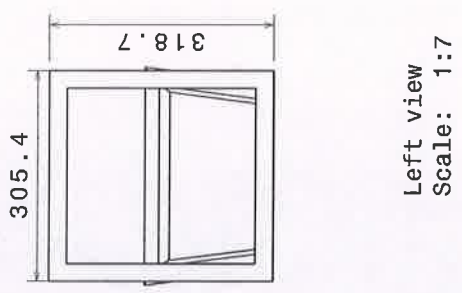
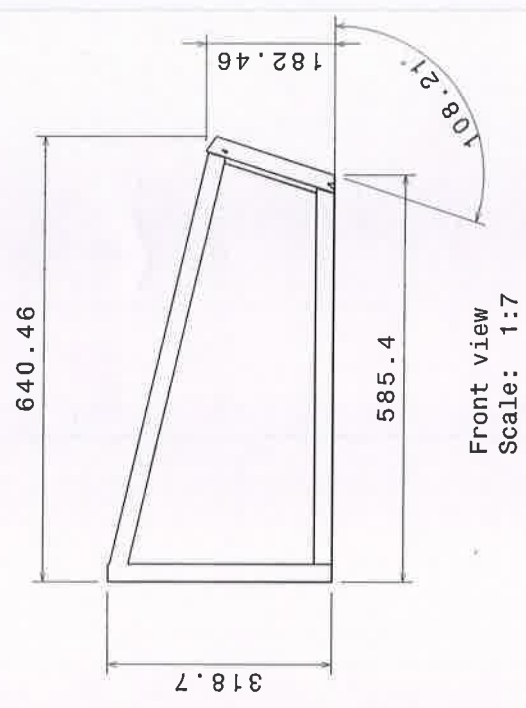
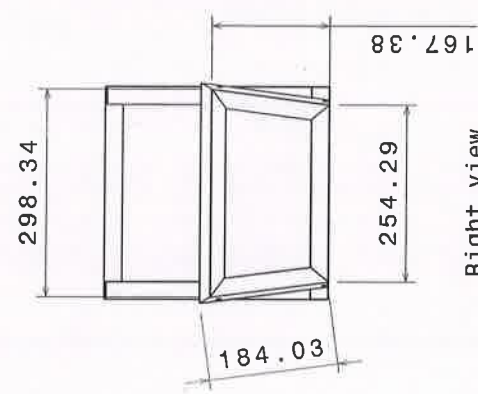

DESIGNED BY:	admin	DATE:	5/22/2019
CHECKED BY:	XXX	DATE:	XXX
SIZE:	A3	REPORT (PG)	1/1
SCALE:	1:1	DRAWING NUMBER:	nose frame
SHEET:	1/1		

This drawing is our property. It can't be reproduced or communicated without our written agreement.

A B C D E F G H

A

C

D

4

3

2

1

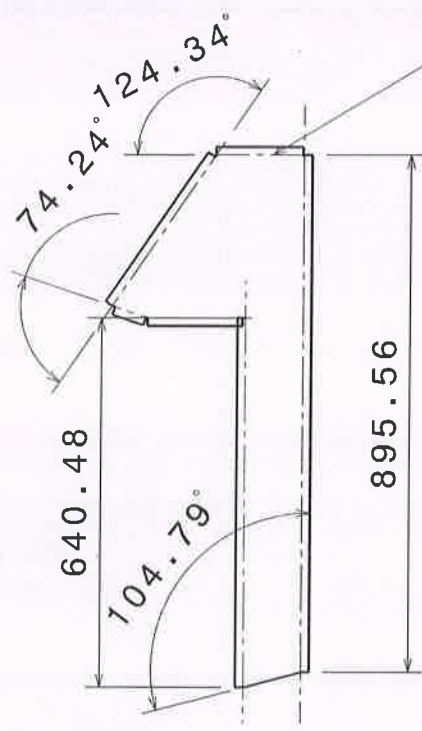

LH Unfolded view
Scale: 1:12

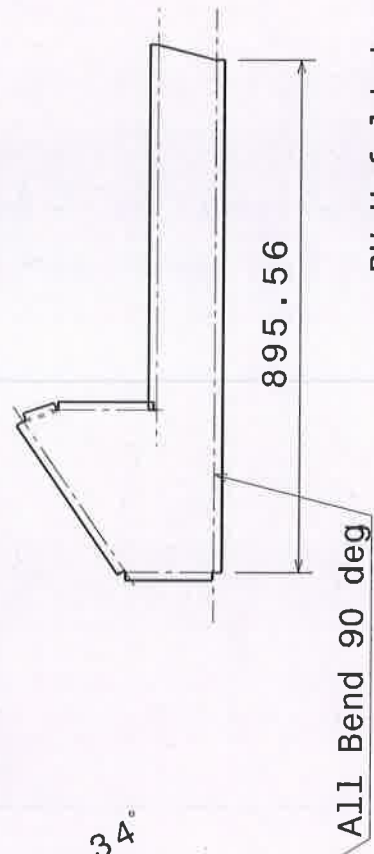

RH Unfolded view
Scale: 1:12



Isometric view
Scale: 1:12

DESIGNED BY: admin		DATE: 6/4/2019		CHECKED BY: XXX		DATE: XXX		SIZE: A4		WEIGHT (Kg): XXX		DRAWING NUMBER: XXX		SHEET: 1/1	
BATMOBILE										Side Lower Sheet					
I	H	G	F	E	D	C	B	A							

This drawing is our property; it can't be reproduced or communicated without our written agreement.

D

A

4

3

2

1

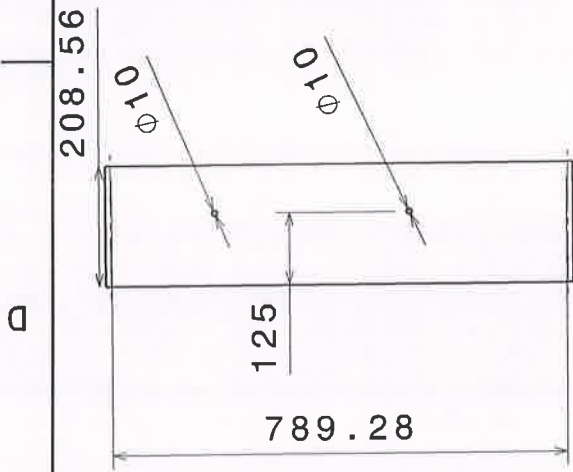

LH Unfolded view
Scale: 1:12

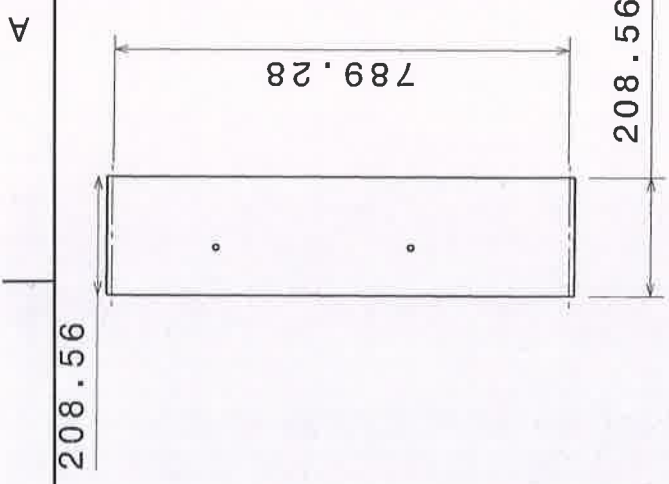

RH Unfolded view
Scale: 1:12

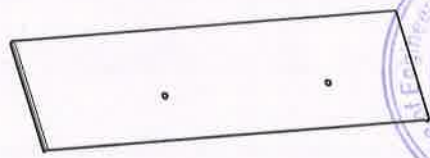

Isometric view
Scale: 1:12







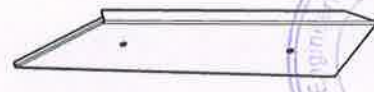
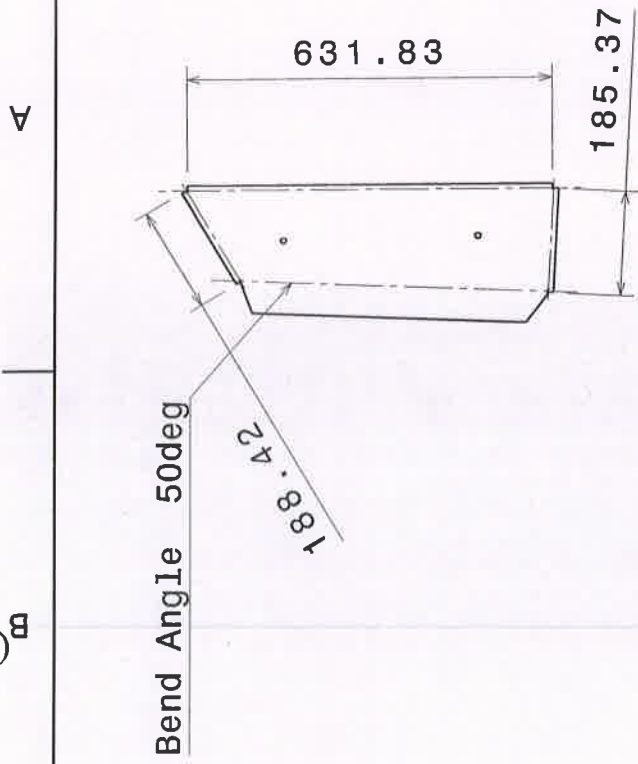
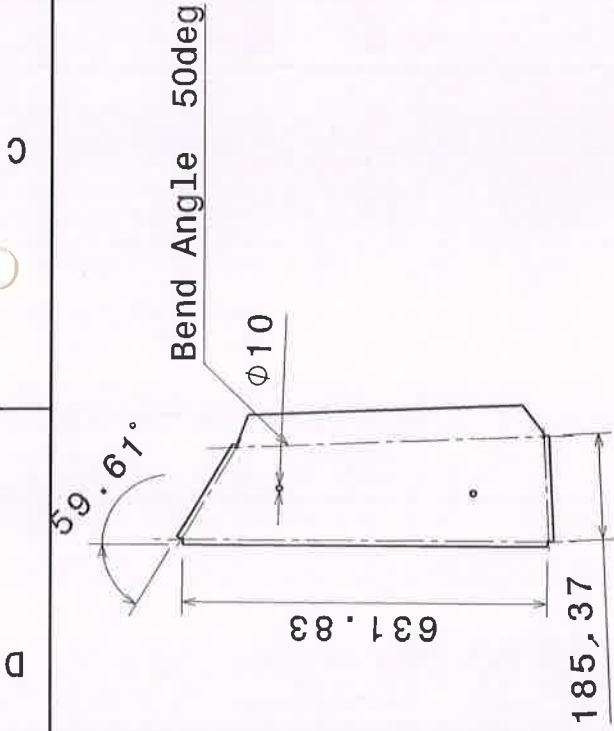

DESIGNED BY:	admin		DRAWING NUMBER	SHEET	1/1	A
DATE:	6/4/2019					
CHECKED BY:	XXX					
DATE:	XXX	WEIGHT (kg)	XXX			
SIZE	A4	SCALE	1:1			
BATMOBILE		Side Sheet 3				
I	-					
H	-					
G	-					
F	-					
E	-					
D	-					
C	-					
B	-					
A	-					

This drawing is our property; it can't be reproduced or communicated without our written agreement.

D A



DESIGNED BY: admin	 	 	 	I
DATE: 6/4/2019				H
CHECKED BY: XXX				G
DATE: XXX	A4	1:1	XXX	F
SIZE	SCALE	WEIGHT (kg)	DRAWING NUMBER	E
	1:1	XXX	XXX	D
				C
				B
				A

BATMOBILE

Side sheet 2

This drawing is our property; it can't be reproduced or communicated without our written agreement.

D

A

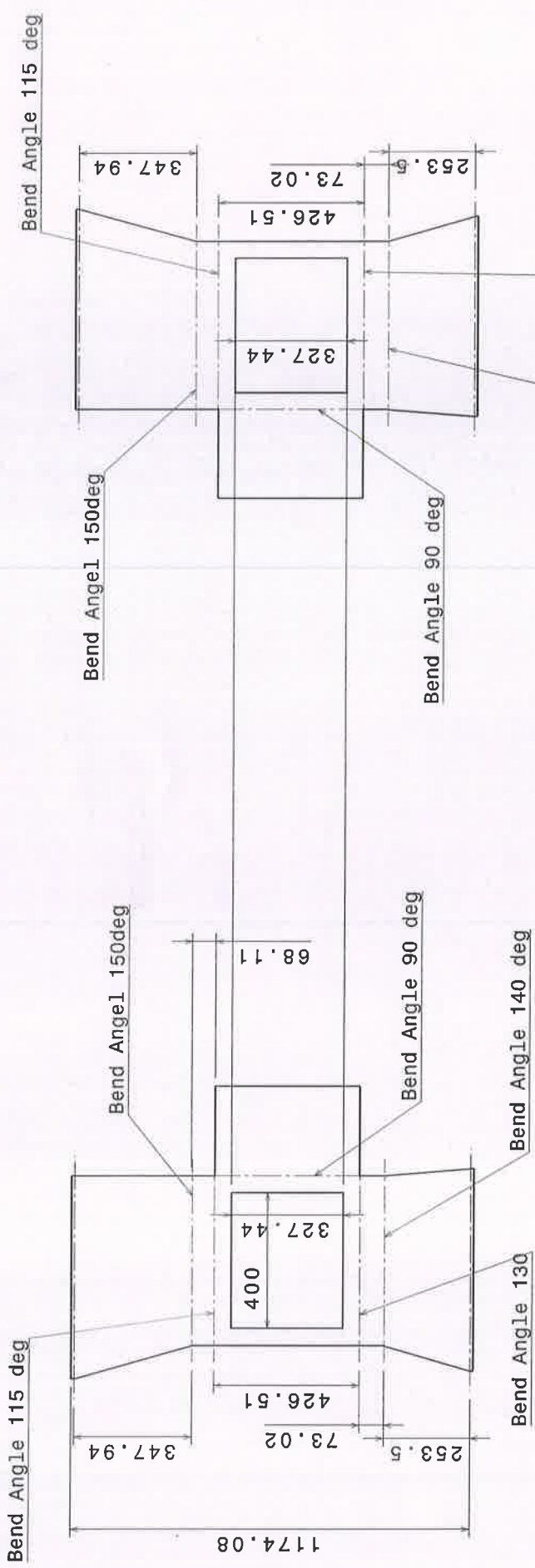

Customer: admin	DATE: 6/4/2019	Checked by: XXX	DATE: XXX	SIZE: A3	WEIGHT (KG):	QUANTITY NUMBER:	SHEET:
				SCALE: 1:1	0.61	side sheet 1	1/1
<p>THIS DRAWING IS OUR PROPERTY. IT CAN'T BE REPRODUCED OR COMMUNICATED WITHOUT OUR WRITTEN AGREEMENT.</p>							

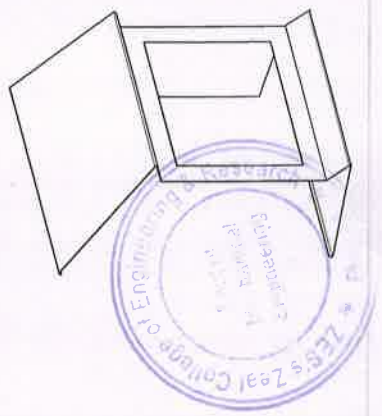

A

B

C

D

760

760

330.2

77.21°

99.99°

330

200

330

330

200

77.21°

99.99°

330.2

LH Unfolded view
Scale: 1:10

RH Unfolded view
Scale: 1:10



Isometric view
Scale: 1:10

DESIGNED BY:	admin		DRAWING NUMBER	SHEET	1/1
DATE:	5/24/2019				
CHECKED BY:	XXX				
DATE:	XXX	SIZE	A4	WEIGHT (kg)	XXX
SCALE		1:1	XXX	This drawing is our property; it can't be reproduced or communicated without our written agreement.	

BATMOBILE

Sheet_55

XXX

XXX

1/1

4

3

2

1

D

A



ZEAL[®]
INSTITUTES
www.zealeducation.com



ZEAL EDUCATION SOCIETY'S
**ZEAL COLLEGE OF ENGINEERING
AND RESEARCH**

Sr.No - 39, Narhe Dhayari Road, Narhe, Pune - 411 041(MS) India.
☎ 020-6720 6000/106 ✉ principal.zcoer@zealeducation.com 🌐 www.zcoer.in
AISHE Code : C-41988 | DTE Code : EN-6298 | SPPU Pun Code : PU/PN/NGG/285/2007
Accredited by NAAC with 'A' Grade

Ref. No.:

Date :

Circular

(Celebration of the Birth Anniversary of Bharat Ratna Dr Babasaheb Ambedkar)

All the student and faculty members are to inform you that as we all know, the birth anniversary of Bharat Ratna Dr. Babasaheb Ambedkar, the architect of the Indian Constitution, falls on April 14th. In honor of his immense contribution to Indian society and to promote his ideas and values, the college will be celebrating his birth anniversary on 14/04/2019 at 10.00am in A building Admission Hall.

We hope that this celebration will help spread awareness about Dr. Ambedkar's work and inspire students to follow in his footsteps.

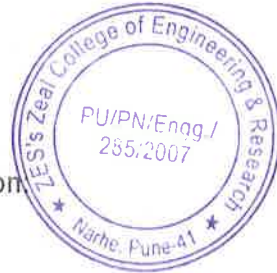

Ajit M. Kate
Dr. Ajit M. Kate
Principal

Copy for Information and Circulation

1. All Head of Departments
2. Office Superintendent



ZEAL[®]
INSTITUTES
www.zealeducation.com



ZEAL EDUCATION SOCIETY'S
**ZEAL COLLEGE OF ENGINEERING
AND RESEARCH**

Sr.No - 39, Narhe Dhayari Road, Narhe, Pune - 411 041(MS) India.
☎ 020-6720 6000/106 ✉ principal.zcoer@zealeducation.com 🌐 www.zcoer.in
AISHE Code : C-41988 | DTE Code : EN-6298 | SPPU Pun Code : PU/PN/NGG/285/2007
Accredited by NAAC with 'A' Grade

Ref. No.:

Date :

**One page report on Celebration of Birth Anniversary of Bharat Ratna Dr. Babasaheb
Ambedkar**

The birth anniversary of Bharat Ratna Dr. Babasaheb Ambedkar, the father of the Indian Constitution, was celebrated on April 14th with great enthusiasm and respect. The occasion was marked to honor the legacy of this great leader and to promote his ideas and values among the students.

The birth anniversary of Bharat Ratna Dr. Babasaheb Ambedkar, the father of the Indian Constitution, was celebrated with great reverence and respect on April 14th. This occasion is a reminder of the immense contribution that Dr. Ambedkar made to Indian society and his tireless efforts to promote equality, justice, and human rights.

The celebration of the birth anniversary of Bharat Ratna Dr. Babasaheb Ambedkar was a great success. The Celebration provided students with an opportunity to learn more about this great leader and his ideas, and also gave them a chance to showcase their talents. The college is proud to have been able to honor the legacy of Dr. Ambedkar and will continue to do so in the years to come.

Principal, Head of Departments, faculty members and students were present for the said occasion.





ZEAL[®]
INSTITUTES
www.zealeducation.com



ZEAL EDUCATION SOCIETY'S
**ZEAL COLLEGE OF ENGINEERING
AND RESEARCH**

📍 Sr.No - 39, Narhe Dhayari Road, Narhe, Pune - 411 041(MS) India.
☎ 020-6720 6000/106 ✉ principal.zcoer@zealeducation.com 🌐 www.zcoer.in
AISHE Code : C-41988 | DTE Code : EN-6298 | SPPU Pun Code : PU/PN/NGG/285/2007
Accredited by NAAC with 'A' Grade

Ref. No.:

Date :



Principal, Head of Departments, faculty members and students paid homage in his remembrance.



Principal, Head of Departments, faculty members and students paid homage in his remembrance.





ZEAL[®]
INSTITUTES
www.zealeducation.com



ZEAL EDUCATION SOCIETY'S
**ZEAL COLLEGE OF ENGINEERING
AND RESEARCH**

Sr.No - 39, Narhe Dhayari Road, Narhe, Pune - 411 041(MS) India.
☎ 020-6720 6000/106 ✉ principal.zcoer@zealeducation.com 🌐 www.zcoer.in
AISHE Code : C-41988 | DTE Code : EN-6298 | SPPU Pun Code : PU/PN/NGG/285/2007
Accredited by NAAC with 'A' Grade

Ref. No.:

Date :

Circular

(Tribute to the great first Maharaja of the Indian princely state of Kolhapur; Chhatrapati Rajarshi Shahu Maharaj)

All the student and faculty members are to inform you that we are giving Tribute to the great first Maharaja of the Indian princely state of Kolhapur; Chhatrapati Rajarshi Shahu Maharaj on 06/05/2019 at 10.00am in A building Admission Hall

It is common for students to pay tribute to historical figures such as Shahu Maharaj as part of their studies and to understand the impact they had on society.



Ajit M. Kate
Dr. Ajit M. Kate
Principal

Copy for Information and Circulation:

1. All Head of Departments
2. Office Superintendent



ZEAL[®]
INSTITUTES

www.zealeducation.com



ZEAL EDUCATION SOCIETY'S
**ZEAL COLLEGE OF ENGINEERING
AND RESEARCH**

Sr.No - 39, Narhe Dhayari Road, Narhe, Pune - 411 041 (MS) India.

☎ 020-6720 6000/106 ✉ principal.zcoer@zealeducation.com 🌐 www.zcoer.in
AISHE Code : C-41988 | DTE Code : EN-6298 | SPPU Pun Code : PU/PN/NGG/285/2007

Accredited by NAAC with 'A' Grade

Ref. No.:

Date :

One page report on Zeal Education Society Pune pays tribute to the great first Maharaja of the Indian princely state of Kolhapur; Chhatrapati Rajarshi Shahu Maharaj !!!

The 100th death anniversary of the legendary people's king, social reformer and true democrat Shri Chhatrapati Rajarshi Shahu Maharaj was celebrated in Zeal Education Society's, Narhe Campus, and Pune on 6th May 2019.

Chhatrapati Rajarshi Shahu Maharaj was a ruler and social reformer from the Indian state of Maharashtra. He was known for his efforts to improve the social and economic status of the lower castes and marginalized communities in his kingdom. It is common for students to pay tribute to historical figures such as Shahu Maharaj as part of their studies and to understand the impact they had on society.

Head of Departments, teaching and non-teaching staff were present for the said occasion.





ZEAL[®] INSTITUTES

www.zealeducation.com



ZEAL EDUCATION SOCIETY'S

ZEAL COLLEGE OF ENGINEERING AND RESEARCH

📍 Sr.No - 39, Narhe Dhayari Road, Narhe, Pune - 411 041(MS) India.

☎ 020-6720 6000/106 ✉ principal.zcoer@zealeducation.com 🌐 www.zcoer.in

AISHE Code : C-41988 | DTE Code : EN-6298 | SPPU Pun Code : PU/PN/NGG/285/2007

Accredited by NAAC with 'A' Grade

Ref. No.:

Date :



Principal, Head of Departments, faculty members and students paid homage in his remembrance.



Principal, Head of Departments, faculty members and students paid homage in his remembrance.





Ref. No.:

Date :

Program Attendance

Sr.No	Name of Student	Class & Div	Sign
	Jaydeep Nikita Nitin	BE Comp	<u>Nikita</u>
	Shreyas Mahari Aiwale	mech	<u>Shreyas</u>
	Prityanka Khadale	Mechanical	<u>Prityanka</u>
	Ritesh Gawali	Mechanical	<u>Ritesh</u>
	Siddhesh Shimpi	Mechanical	<u>Siddhesh</u>
	Madhura Mahajan	Mech	<u>Madhura</u>
	Bhargav Aditya Sathish	BE A Comp	<u>Bhargav</u>
	Piyush Miteagote	mech	<u>Piyush</u>
	Akash Katore	<u>Akash</u>	mech
	Deshmukh Pranjali S.	BE A Comp	<u>Pranjali</u>
	Omkar Chhapalgaonkar	BE Mech	<u>Omkar</u>
	Swati Tupe	BE-B -IT	<u>Swati</u>
	Kedar Pingale Dilip	BE-B IT	<u>Kedar</u>
	Omkar Sujar	BE-A IT	<u>Omkar</u>





ZEAL[®]
INSTITUTES
www.zealeducation.com



ZEAL EDUCATION SOCIETY'S
**ZEAL COLLEGE OF ENGINEERING
AND RESEARCH**

Sr.No - 39, Narhe Dhayari Road, Narhe, Pune - 411 041(MS) India.
020-6720 6000/106 principal.zcoer@zealeducation.com www.zcoer.in
AISHE Code : C-41988 | DTE Code : EN-6298 | SPPU Pun Code : PU/PN/NGG/285/2007
Accredited by NAAC with 'A' Grade

Ref. No.:

Date :

Circular

(Celebration of Rajmata Jijau Jayanti and Swami Vivekananda Jayanti (National Youth Day))

All the student and faculty members are to inform you that Rajmata Jijau Jayanti, the birth anniversary of the revered mother of Chhatrapati Shivaji Maharaj and Swami Vivekananda Jayanti (National Youth Day) will be celebrated in our institution on 12/01/2020 at 10.00am in A building Admission Hall

We would like to encourage all students to participate in these activities and celebrate this day with reverence and respect for Rajmata Jijau's legacy.



Ajit Kate
Dr.Ajit M.Kate
Principal

Copy for Information and Circulation:

1. All Head of Departments
2. Office Superintendent



ZEAL[®]
INSTITUTES
www.zealeducation.com



ZEAL EDUCATION SOCIETY'S
**ZEAL COLLEGE OF ENGINEERING
AND RESEARCH**

Sr.No - 39, Narhe Dhayari Road, Narhe, Pune - 411 041(MS) India.
☎ 020-6720 6000/106 ✉ principal.zcoer@zealeducation.com 🌐 www.zcoer.in
AISHE Code : C-41988 | DTE Code : EN-6298 | SPPU Pun Code : PU/PN/NGG/285/2007
Accredited by NAAC with 'A' Grade

Ref. No.:

Date :

**One page report on Celebration of Rajmata Jijau Jayanti and Swami Vivekananda Jayanti
(National Youth Day)**

Zeal Education Society's Narhe Campus, Pune paid tribute to Rajmata Jijau Bhosale, the mother of Chatrapathi Shivaji Maharaj and Swami Vivekananda, a great philosopher & social reformer on their birth anniversary.

Rajmata Jijau Jayanti marks the day when Chatrapathi Shivaji Maharaj's mother, Jijabai Bhosale, Kingmaker and A Powerful Feminist Woman was born, on January 12.

Rajmata Jijau Jayanti honours Rajmata for her role in shaping Shivaji Maharaj's life, the strong upbringing she gave him and how it helped him become the great leader of the Maratha empire. It was Jijamata's courage, strong sense of duty, self-respect and resilience that inspired Shivaji Maharaj to become the greatest Maratha ruler and warrior. Rajmata Jijau Bhosale was a feminist who believed in doing the right thing, no matter what the circumstances.

National Youth Day, also known as Swami Vivekananda Jayanti, is celebrated in India on January 12 to commemorate the birth anniversary of Swami Vivekananda, one of India's most influential spiritual leaders and thinkers. He was a philosopher, monk, and teacher who played a key role in the Indian independence movement and the resurgence of Hinduism in India. He is also known for his contributions to the field of education and his efforts to empower the youth of India. His teachings on education, nationalism, and spirituality continue to be relevant and have a great impact on the youth of India.

Dr. Ajit M. Kate Principal, Zeal College of Engineering and Research, Pune, Head of Departments, faculty members and students paid homage in his remembrance.





ZEAL[®]
INSTITUTES
 www.zealeducation.com



ZEAL EDUCATION SOCIETY'S
**ZEAL COLLEGE OF ENGINEERING
 AND RESEARCH**

📍 Sr.No - 39, Narhe Dhayari Road, Narhe, Pune - 411 041(MS) India.
 ☎ 020-6720 6000/106 ✉ principal.zcoer@zealeducation.com 🌐 www.zcoer.in
 AISHE Code : C-41988 | DTE Code : EN-6298 | SPPU Pun Code : PU/PN/NGG/285/2007
 Accredited by NAAC with 'A' Grade

Ref. No.:

Date :



Dr. Ajit M. Kate Principal, Zeal College of Engineering and Research, Pune, Head of Departments, faculty members and students paid homage in his remembrance.



Faculty members and students paid homage in his remembrance.





ZEAL
INSTITUTES

www.zealeducation.com



ZEAL EDUCATION SOCIETY'S

**ZEAL COLLEGE OF ENGINEERING
AND RESEARCH**

Sr.No - 39, Narhe Dhayari Road, Narhe, Pune - 411 041 (MS) India.
☎ 020-6720 6000/106 ✉ principal.zcoer@zealeducation.com 🌐 www.zcoer.in
AISHE Code : C-41988 | DTE Code : EN-6298 | SPPU Pun Code : PU/PN/NGG/285/2007
Accredited by NAAC with 'A' Grade

Ref. No.:

Date :

Program Attendance

Sr.No	Name of Student	Class & Div	Sign
	Chavan Anjali Ajit	SE A Comp	<u>Chavan</u>
	Amruta Patil S.	BE-B-IT	<u>Amruta</u>
	Pawar Siddhanta Rajendra	TE B Comp	<u>Pawar</u>
	Chavan Nana mahadeo	BE A	<u>Nana</u>
	Hake pooja sanjay	SE A Comp	<u>Pooja</u>
	Sonika Babhe	TE Mech	<u>Babhe</u>
	Bhosale Aswini Raju	BE A Comp	<u>Bhosale</u>
	Ajay mahamuni Sanjay	TE-B IT	<u>Ajay</u>
	Kusur prajakta sandip	SEA Comp	<u>Kusur</u>
	Azim Shaikh Azi2	BE-B-IT	<u>Azim</u>
	Bhilase vaibhav Ashok	BE A Comp	<u>Vaibhav</u>
	Nale Rajesh L.	BE-B Comp IT	<u>Rajesh Nale</u>
	Chavan mamata Prakash	BE-A IT	<u>Mamata</u>
	Omkar Patil Prakash	TE-B IT	<u>Patil Omkar</u>
	Jyoti Kambale	TE-A IT	<u>Joti Kambale</u>
	Gupta Jyoti Lalam	BE-A IT	<u>Jyoti</u>
	Shinde Aditya Anvinda	BE-A IT	<u>Shinde</u>
	Akshay Ramesh Chavan	FE-Mech	<u>Chavan</u>





Zeal Education Society's
**ZEAL COLLEGE OF ENGINEERING AND
RESEARCH**
S.No. 39, Narhe, Pune-411041, India
Department of Mechanical Engineering
ZEAL DRAG 3.0
2018- 2019



OBJECTIVES OF ZEAL DRAG

- To support the skill India program by Government of India.
- To promote **GOKART** as a sport in India
- Engineering Student all over India will be benefited as it will serve as a platform to reinforce their vehicle design and manufacturing Knowledge
- To enhance the technical skills, confidence and sporting spirit of the students.
- Provide a standard platform to showcase their talent and potential in the field of design and manufacturing
- To inculcate team-work, entrepreneurial skills and management skills in students.

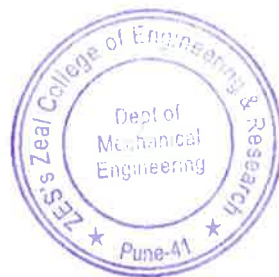

DEPARTMENT OF MECHANICAL ENGINEERING



Zeal Education Society's
**ZEAL COLLEGE OF ENGINEERING AND
RESEARCH**
S.No. 39, Narhe, Pune-411041, India
Department of Mechanical Engineering
ZEAL DRAG 3.0
2018- 2019



TEAMS PARTICIPATED

Sr No	Team Name
1	Team Abhyudaya
2	Team Acet Raptors
3	Team Ashwamegh
4	Team Black Spanner
5	Team Crankers
6	Team Empezars
7	Team Engine-Er's Kart,
8	Team Foster Racers
9	Team Glycon 4.0'
10	Team Glycon 5.0
11	Team Inception
12	Team Invictus Racing,
13	Team Mirage
14	Team Overdrive,
15	Team Phalanx Racing
16	Team Pravega
17	Team Resonanceracing'
18	Team Spartans,
19	Team STALLON KARTEN
20	Team Thunderspark
21	Team Wrench Welders Racing
22	Team XELERATE
23	Team Abhyudaya
24	Team Acet Raptors

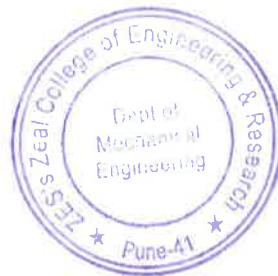

DEPARTMENT OF MECHANICAL ENGINEERING



Zeal Education Society's
**ZEAL COLLEGE OF ENGINEERING AND
RESEARCH**
S.No. 39, Narhe, Pune-411041, India
Department of Mechanical Engineering
ZEAL DRAG 3.0
2018- 2019



EVENTS

1. VIRTUAL ROUND- I

Date: 21st January 2018

Venue: Department of Mechanical Engineering, ZCOER, Pune

Participants:

Sr No	Team Name
1	Team Abhyudaya
2	Team Acet Raptors
3	Team Ashwamegh
4	Team Black Spanner
5	Team Crankers
6	Team Empezars
7	Team Engine-Er's Kart,
8	Team Foster Racers
9	Team Glycon 4.0'
10	Team Glycon 5.0
11	Team Inception
12	Team Invictus Racing.
13	Team Mirage
14	Team Overdrive,
15	Team Phalanx Racing
16	Team Pravega
17	Team Resonanceracing'
18	Team Spartans,
19	Team STALLON KARTEN
20	Team Thunderspark
21	Team Wrench Wielders Racing
22	Team XELERATE
23	Team Abhyudaya
24	Team Acet Raptors

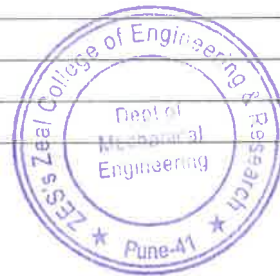

DEPARTMENT OF MECHANICAL ENGINEERING



Zeal Education Society's
**ZEAL COLLEGE OF ENGINEERING AND
RESEARCH**
S.No. 39, Narhe, Pune-411041, India
Department of Mechanical Engineering
ZEAL DRAG 3.0
2018- 2019



Virtual Round Guidelines

- 1) Virtual round having 100 marks and Virtual Test have will be conducted on 16th March 2019. Time-11.00am to 11.30 am
- 2) Virtual contents 100 marks and these points also considered for overall ranking. Distribution of 100 Marks is tabulated below

Sr.	Description	Marks
1	Questions on Automobile Engineering	50 Marks
2	Questions on Manufacturing Engineering	20 Marks
3	Questions on Rulebook	10 Marks
4	Virtual PPT content	10 Marks
5	Virtual PPT Video	10 Marks

Total 100 Marks

- 3) Virtual MCQ Test of 80 marks will be online open source test.
- 4) Time period for test (30 Minutes for 40 Questions).
- 5) Virtual MCQ Test will be open source test.
- 6) Test timing, Login ID and passwords for Test will be mailed on registered mail ID mentioned in registration form.

Presentation Guidelines.

- 1) Presentations to be made in MS PowerPoint, and should be compatible to run in MS PowerPoint 2007.
- 2) A maximum of 14 slides can be used.
- 8) Virtual presentation should not be more than 15 minutes
- 4) Slide Sequence is given below.

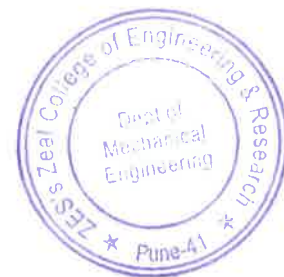

DEPARTMENT OF MECHANICAL ENGINEERING



Zeal Education Society's
**ZEAL COLLEGE OF ENGINEERING AND
RESEARCH**
S.No. 39, Narhe, Pune-411041, India
Department of Mechanical Engineering
ZEAL DRAG 3.0
2018- 2019



Slide Particulars

- 1 Team Name and College Name with logos.
- 2 Vehicle Technical Specifications
- 3 Design Methodology
- 4 CAE Model with results
- 5 Brakes System
- 6 Steering and wheel geometry
- 7 Power Train
- 8 Cost and weight analysis Pie-Chart
- 9 Project Plan
- 10 DFMEA
- 11 Design Validation Plan
- 12 Team composition with work allocation; Faculty advisor name,
- 13 College workshop facilities.
- 14 Innovation (if applicable)



DEPARTMENT OF MECHANICAL ENGINEERING



Zeal Education Society's
**ZEAL COLLEGE OF ENGINEERING AND
RESEARCH**
S.No. 39, Narhe, Pune-411041, India
Department of Mechanical Engineering
ZEAL DRAG 3.0
2018- 2019



2. MAIN EVENT

Date: 16th – 19st March 2019

Venue: Zeal College of Engineering And Research, Narhe , Pune

The inauguration of the program was done by Mr. Satish Hirve, Head, Sourcing Department, Ashok Leyland in presence of Mr. Jayesh S. Katkar, Executive Director, ZES, Dr. Sanjay Deokar, Campus Director, ZCOER, Dr. Kate A.M., Principal, ZCOER-Pune, Dr. Dambhare S. G. Convener, Zeal Drag & H.O.D, Mechanical Department (Shift-I),

Main event was divided in to two categories namely Static round and Dynamic round, under which different events were conducted as tabulated below.

S.N.	CATEGORY	EVENT	MAXIMUM POINTS
1	STATIC ROUND	Vehicle Design Vs Analysis	100
2		Cost Report Vs Vehicle Cost	150
1	DYNAMIC ROUND	Skid Pad	50
2		Auto cross	50
3		Drag Race	100
4		Endurance	150
5		Tug Of War	150
Total			600



Static Tests

DEPARTMENT OF MECHANICAL ENGINEERING



Zeal Education Society's
**ZEAL COLLEGE OF ENGINEERING AND
RESEARCH**
S.No. 39, Narhe, Pune-411041, India
Department of Mechanical Engineering
ZEAL DRAG 3.0
2018- 2019



Technical inspection of all participating teams was done on day one in which Kart was inspected by experts from Automotive Industry. In technical inspection Kart was tested to check whether it is manufactured according to specification given in the rulebook or not. After successful completion of Technical Inspection teams were eligible for the brake test.

Design Report VS Vehicle Analysis

The vehicle will be verified with the design report and not even a single alteration would be entertained in the vehicle from the design report.

Dynamic Tests

BRAKE TEST

It was mandatory for a vehicle to pass the brake test to participate in any of the dynamic events. The brake test was conducted on 8m straight course of track with speed of 40km/hr while attempting brake test.

The vehicle must stop in a straight line after the brake is applied on the vehicle and the wheels on which the brake mechanism is acting must get locked immediately after pedal is pressed as well as break light must blink. Each vehicle was given only three attempts to pass the brake test. Vehicle dynamic stability was also checked during the test. Only two teams were disqualified in brake test.

Acceleration Test

The acceleration of the kart was evaluated during the brake test. Acceleration of the vehicle in attempt in which the vehicle is passing brake test was considered as final.

Autocross



DEPARTMENT OF MECHANICAL ENGINEERING



Zeal Education Society's
**ZEAL COLLEGE OF ENGINEERING AND
RESEARCH**

S.No. 39, Narhe, Pune-411041, India
Department of Mechanical Engineering

ZEAL DRAG 3.0

2018-2019



The objective of the autocross event was to evaluate the vehicle's maneuverability and handling qualities on a tight course without the hindrance of competing vehicles. The autocross track was designed to evaluate combined performance features of acceleration, braking, and cornering ability.

Endurance

The Endurance Event was conducted on day 3. It was designed to evaluate the overall performance of the vehicle and to test the vehicle's reliability.

Skid Pad

The objective of the skid-pad event was to measure the vehicle's cornering ability on a flat surface while making a constant-radius turn. The skid pad layout was a figure of 8

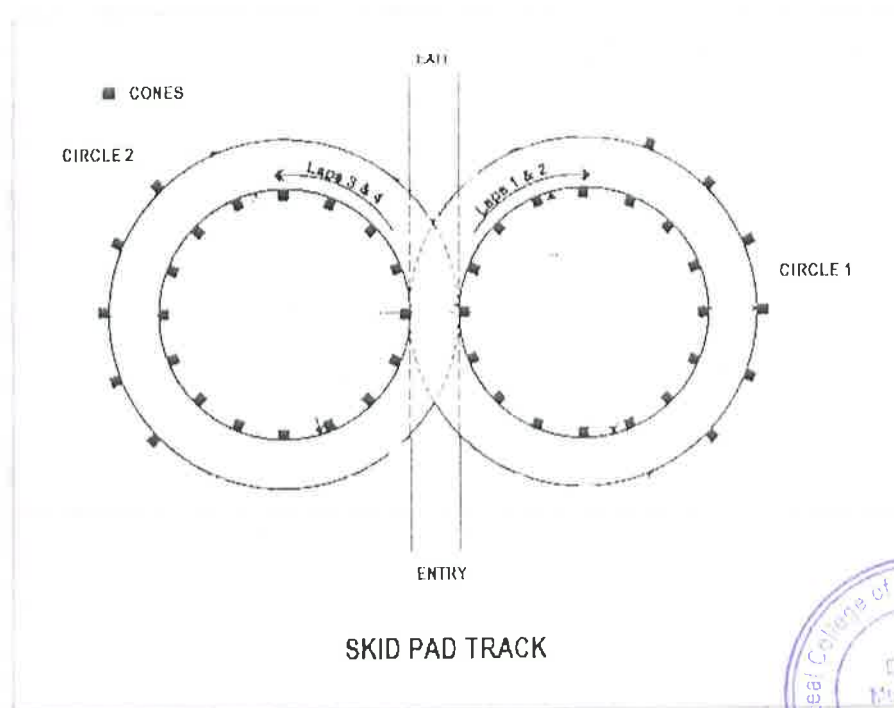

Drag Test



DEPARTMENT OF MECHANICAL ENGINEERING



Zeal Education Society's
**ZEAL COLLEGE OF ENGINEERING AND
RESEARCH**
S.No. 39, Narhe, Pune-411041, India
Department of Mechanical Engineering
ZEAL DRAG 3.0



2018- 2019

Drag racing is a type of motor racing in which karts compete, usually two at a time, to cross a set finish line. The race follows a short, straight course from a standing start over a measured distance. Electronic timing has been used to record race results. It was conducted on day 2 of the event.

Tug of War

GALLERY

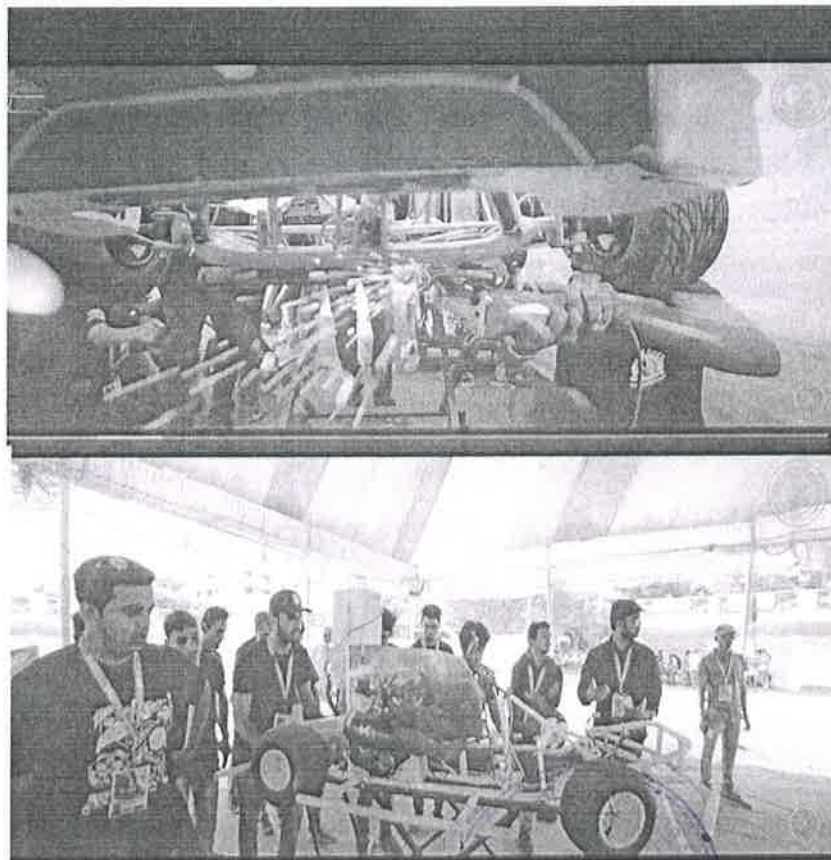

DEPARTMENT OF MECHANICAL ENGINEERING



Zeal Education Society's
**ZEAL COLLEGE OF ENGINEERING AND
RESEARCH**
S.No. 39, Narhe, Pune-411041, India
Department of Mechanical Engineering
ZEAL DRAG 3.0
2018- 2019

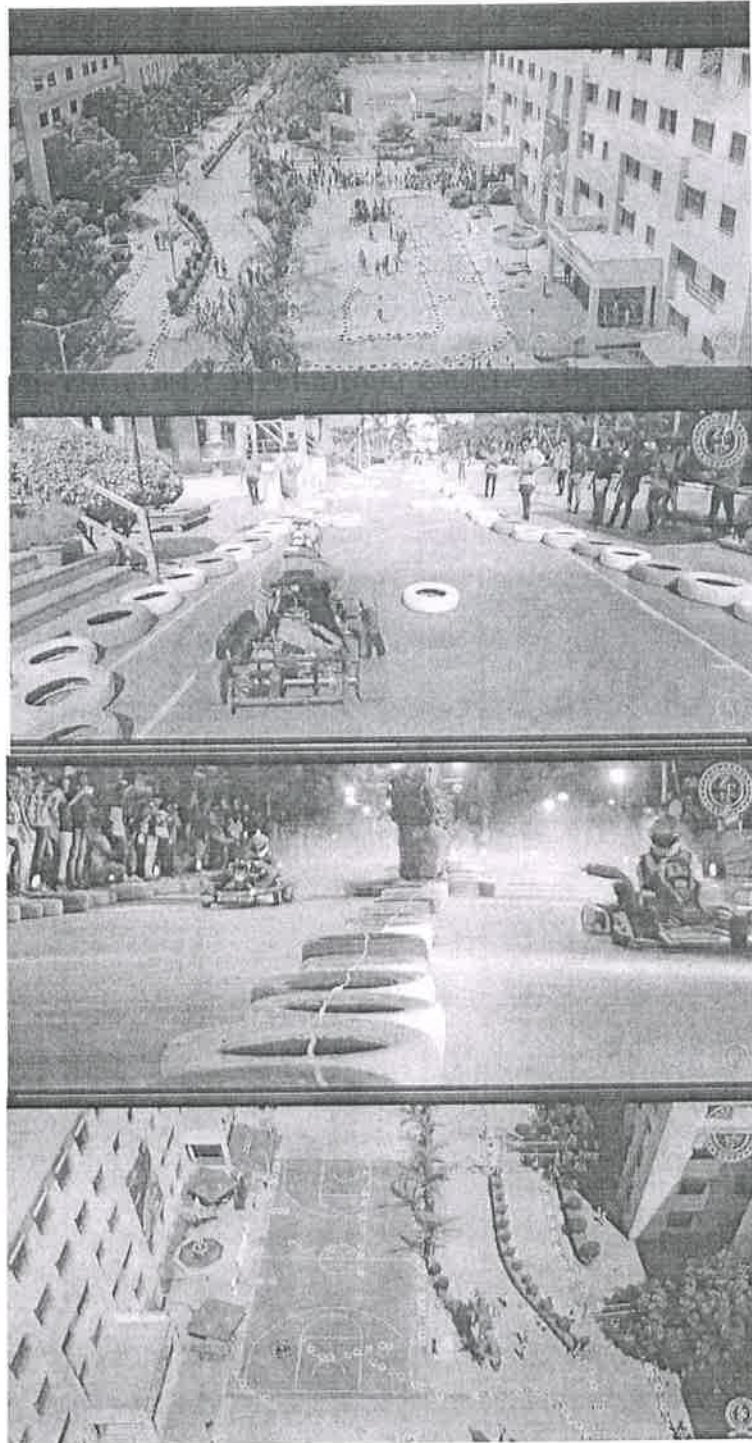

DEPARTMENT OF MECHANICAL ENGINEERING



Zeal Education Society's
**ZEAL COLLEGE OF ENGINEERING AND
RESEARCH**
S.No. 39, Narhe, Pune-411041, India
Department of Mechanical Engineering
ZEAL DRAG 3.0
2018- 2019



ZEAL DRAG 2018-19 Volunteer List

Sr.No	Volunteer	Name	Class
1	ZD2.001	Neeraj Gole (TL)	BE
2	ZD2.002	Sagar Gondkar (TL)	BE
3	ZD2.003	Saurabh bharambe	BE
4	ZD2.004	Lokesh Harle	BE
5	ZD2.005	Shreyas Bhosale	BE
6	ZD2.006	Ghanashyam Jorwar	BE
7	ZD2.007	Yash Ghayal	BE
8	ZD2.008	Bharat Chougale	BE
9	ZD2.009	Akash kadam	BE
10	ZD2.010	Akhil Bhat	BE
11	ZD2.011	Rushikesh bade	BE
12	ZD2.012	Bhagat Prathamesh	BE
13	ZD2.013	Haris bagwan	BE
14	ZD2.014	Sahil Gharat (TL)	BE
15	ZD2.015	Ritesh Gawali (TL)	BE
16	ZD2.016	Gautam Jahagirdar	BE
17	ZD2.017	Suyog Gosavi	BE
18	ZD2.018	Akhil Bhat	BE
19	ZD2.019	Rushikesh Bade	BE
20	ZD2.020	Abhishek Kulkarni	BE
21	ZD2.021	Pankaj Khot	BE
22	ZD2.022	Onkar Chapalgaonkar	BE
23	ZD2.023	Kaustubh Dixit	BE
24	ZD2.024	Akash Jeevan Divate	BE
25	ZD2.025	Chetan Chaudhari	BE
26	ZD2.026	Shubham Awasare	BE
27	ZD2.027	Vrushabh Desai	BE
28	ZD2.028	Nikhil Janave	BE
29	ZD2.029	Abhishek Shimpi	BE
30	ZD2.030	Pratik Talvar	BE
31	ZD2.031	Atish Katore	BE
32	ZD2.032	Siddhesh Shinde	BE
33	ZD2.033	Shashikant Gaikwad	BE
34	ZD2.034	Yadnesh Gulhane	BE

DEPARTMENT OF MECHANICAL ENGINEERING

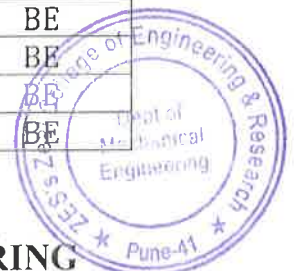



Zeal Education Society's
**ZEAL COLLEGE OF ENGINEERING AND
RESEARCH**
S.No. 39, Narhe, Pune-411041, India
Department of Mechanical Engineering
ZEAL DRAG 3.0
2018- 2019



Organizing Committee

Akshay Karande	Contact Point Person, Event Management, Technical Committee & Rulebook
Pravin Parit	Contact Point Person, Event Management execution
Ajinkya Dawale	Dynamic events, Volunteer training
Vikas Patil	Website Design & Update
Tausif Shaikh	VIP Relationship , Transport
Junaid Deshmukh	Secretary (Finance &Accounts)
Abhijit Kasar	Marketing,, Hotel ,Catering committee
Vitthal Randive	Event Registration Head.
Suhas Sawant	Endurance, Dynamic Event, Track Management & Safety
Sachin Godase	VIP Relationship ,Hospitality ,Guest Relationship



**Head Of Department
Mechanical Engineering**

DEPARTMENT OF MECHANICAL ENGINEERING



Zeal Education Society's
**ZEAL COLLEGE OF ENGINEERING AND
RESEARCH**
S.No. 39, Narhe, Pune-411041, India
Department of Mechanical Engineering
ZEAL DRAG 2.0
2017- 2018



OBJECTIVES OF ZEAL DRAG

- To support the skill India program by Government of India.
- To promote **GOKART** as a sport in India
- Engineering Student all over India will be benefited as it will serve as a platform to reinforce their vehicle design and manufacturing Knowledge
- To enhance the technical skills, confidence and sporting spirit of the students.
- Provide a standard platform to showcase their talent and potential in the field of design and manufacturing
- To inculcate team-work, entrepreneurial skills and management skills in students.

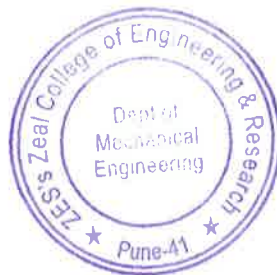

DEPARTMENT OF MECHANICAL ENGINEERING



Zeal Education Society's
**ZEAL COLLEGE OF ENGINEERING AND
RESEARCH**
S.No. 39, Narhe, Pune-411041, India
Department of Mechanical Engineering
ZEAL DRAG 2.0
2017- 2018



TEAMS PARTICIPATED

Sr No	Team Name
1	TEAM ADVAITA
2	TEAM AUTOMACHEN
3	TEAM BITZ
4	TEAM BLACKSPANNERS
5	TEAM BLITZWIFTERZ2.0
6	TEAM CAMPEONES
7	TEAM FLASH
8	TEAM HURACAN MOTORSPORTS
9	TEAM INVADER RACING
10	TEAM KART KILLERS
11	TEAM KARTERS
12	TEAM KRAKENS
13	TEAM LIGHTNING ARJUNA
14	TEAM MACHINIST
15	TEAM MECH-ANIMALS
16	TEAM MECHFLAMMA RACER
17	TEAM NEXUSRACING
18	TEAM PEGASUS
19	TEAM ROADRUNNER
20	TEAM SCREWDRIVERS
21	TEAM SCORPIONS
22	TEAM SMOKING PISTON
23	TEAM SPEED DEMONS K-II
24	TEAM SPEED DEMONS K-III
25	TEAM STALLION KARTING
26	TEAM TACHYON
27	TEAM TORQUE RANGER
28	TEAM TRITANS
29	TEAM TRIDENT
30	TEAM MECH-CHEETAH
31	TEAM PINAKA

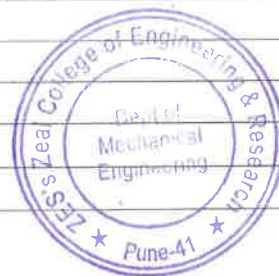

DEPARTMENT OF MECHANICAL ENGINEERING



Zeal Education Society's
**ZEAL COLLEGE OF ENGINEERING AND
RESEARCH**

S.No. 39, Narhe, Pune-411041, India

Department of Mechanical Engineering

ZEAL DRAG 2.0

2017- 2018



EVENTS

1. VIRTUAL ROUND- I

Date: 21st January 2017

Venue: Department of Mechanical Engineering, ZCOER, Pune

Participants:

Sr No	Team Name
1	TEAM ADVAITA
2	TEAM AUTOMACHEN
3	TEAM BITZ
4	TEAM BLACKSPANNERS
5	TEAM BLITZWIFTERZ2.0
6	TEAM CAMPEONES
7	TEAM FLASH
8	TEAM HURACAN MOTORSPORTS
9	TEAM INVADER RACING
10	TEAM KART KILLERS
11	TEAM KARTERS
12	TEAM KRAKENS
13	TEAM LIGHTNING ARJUNA
14	TEAM MACHINIST
15	TEAM MECH-ANIMALS
16	TEAM MECHFLAMMA RACER
17	TEAM NEXUSRACING
18	TEAM PEGASUS
19	TEAM ROADRUNNER
20	TEAM SCREWDRIVERS
21	TEAM SCORPIONS
22	TEAM SMOKING PISTON
23	TEAM SPEED DEMONS K-II



DEPARTMENT OF MECHANICAL ENGINEERING



Zeal Education Society's
**ZEAL COLLEGE OF ENGINEERING AND
RESEARCH**
S.No. 39, Narhe, Pune-411041, India
Department of Mechanical Engineering
ZEAL DRAG 2.0
2017- 2018



The inauguration of the program was done by Dr. Kate A.M., Principal, ZCOER-Pune in presence of Dr. Dambhare S. G. Convener, Zeal Drag & H.O.D. Mechanical Department (Shift-I), Dr. Ubale A. B. H.O.D. Mechanical Department (Shift-II).

Description:

The event was organized to verify the feasibility of design for each vehicle based on following criteria's

1. Chassis design
2. Steering Design
3. Break Design
4. Engine Selection
5. Business Plan
6. Innovation
7. DESIGN FAILURE MODE EFFECTIVE (DFMEA)
8. Gantt Chart

Eminent personalities form industry as well as academies were appointed as the judges. Students presented their work and planning to these judges, evaluation of these participating teams was done based on their presentation and quality of their work. Judges also suggested the modification (if required) to the teams.

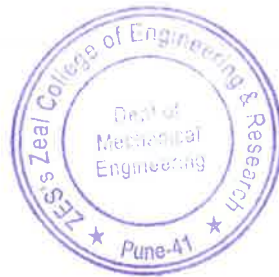

DEPARTMENT OF MECHANICAL ENGINEERING



**Zeal Education Society's
ZEAL COLLEGE OF ENGINEERING AND
RESEARCH**

S.No. 39, Narhe, Pune-411041, India

Department of Mechanical Engineering

ZEAL DRAG 2.0

2017- 2018



EVALUATION CRITERIA

Sr. No.	Categories	Particulars	Criteria Description	Total Marks	Marks Scored
1	VehicleDesign	Vehicle Specifications	Preliminary technical specifications & overall performance targets. 2D/ 3D views of the proposed vehicle design.	15	
2		Rulebook Knowledge	Adherence to Rulebook and knowledge of all the rules.	15	
3		Roll Cage	Design methodology for roll cage, proposed engineering process for FEA – load cases and constraints, criteria for Factor of Safety & deformations. Actual FEA results and interpretation. Ergonomics knowledge related to vehicle cock pit lay out – driver seating lay out, ease of egress, vision and controls.	30	
4		Steering	Design considerations/lay out/basic calculations for selection of steering gear, turning circle, turning angles, camber and caster angles, etc.	30	
5		Powertrain	Design considerations/lay out/basic calculations. Engine Specification, Vehicle performance prediction e.g. vehicle max speed, acceleration, etc.	30	
6		Brakes	Design considerations/lay out/basic calculations for brake's type selection (disc/ drum brakes). brake circuit lay out/actuation, dynamic load transfer, stopping distance, deceleration, pedal effort etc.	30	

DEPARTMENT OF MECHANICAL ENGINEERING



Zeal Education Society's
**ZEAL COLLEGE OF ENGINEERING AND
RESEARCH**
S.No. 39, Narhe, Pune-411041, India
Department of Mechanical Engineering
ZEAL DRAG 2.0



2017- 2018

7	Cost Report	Costing	Cost estimates, financing for the project	30	
8	Gantt Chart	Planning	Manufacturing Process and Process plan, Gantt Charts.	30	
9	Design Validation	DVP & DFMEA	Validation Plan, DFMEA Report.	30	
10	Innovation	Innovation & Ergonomics	Ergonomics Consideration and Innovations in Vehicle.	30	
11	Presentation	Q&A	Ability to answer the questions.	15	
12	Design Report	Hard Copy	Virtual Report work	15	
			Total	300	



DEPARTMENT OF MECHANICAL ENGINEERING



Zeal Education Society's
ZEAL COLLEGE OF ENGINEERING AND
RESEARCH
S.No. 39, Narhe, Pune-411041, India
Department of Mechanical Engineering
ZEAL DRAG 2.0
2017- 2018



2. MAIN EVENT

Date: 30th – 31st March – 1st April 2017

Venue: Zeal College of Engineering And Research, Narhe , Pune

The inauguration of the program was done by Mr. Satish Hirve, Head, Sourcing Department, Ashok Leyland in presence of Mr. Jayesh S. Katkar, Executive Director, ZES, Dr. Sanjay Deokar, Campus Director, ZCOER, Dr. Kate A.M., Principal, ZCOER-Pune, Dr. Dambhare S. G. Convener, Zeal Drag & H.O.D, Mechanical Department (Shift-I), Dr. Ubale A. B. H.O.D, Mechanical Department (Shift-II).

Main event was divided in to two categories namely Static round and Dynamic round, under which different events were conducted as tabulated below.

S.N.	CATEGORY	EVENT	MAXIMUM POINTS
1	STATIC ROUND	Vehicle Design Vs Analysis	50
2		Cost Report Vs Vehicle Cost	50
4		Manufacturing Quality	100
5		Design Report Discussion	50
6		Innovation (Implimentation)	50
7		Business case presntation	50
1		DYNAMIC ROUND	Skid Pad
2	Auto cross		50
3	Drag Race		100
4	Endurance		150
Total			700

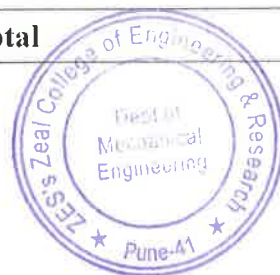

DEPARTMENT OF MECHANICAL ENGINEERING



Zeal Education Society's
**ZEAL COLLEGE OF ENGINEERING AND
RESEARCH**
S.No. 39, Narhe, Pune-411041, India
Department of Mechanical Engineering
ZEAL DRAG 2.0
2017- 2018



Static Tests

TECHNICAL INSPECTION

Technical inspection of all participating teams was done on day one in which Kart was inspected by experts from Automotive Industry. In technical inspection Kart was tested to check whether it is manufactured according to specification given in the rulebook or not. After successful completion of Technical Inspection teams were eligible for the brake test.

Design Report VS Vehicle Analysis

The vehicle will be verified with the design report and not even a single alteration would be entertained in the vehicle from the design report.

Tilt Test

In this vehicle will check for fuel leak at 45 degree tilted position.

Egress Test

Maximum driver out time is 5sec, within this interval of time driver has to come out of the vehicle.

Go and No-Go Test.

This is done for check overall dimensions of vehicle.



DEPARTMENT OF MECHANICAL ENGINEERING



Zeal Education Society's
**ZEAL COLLEGE OF ENGINEERING AND
RESEARCH**
S.No. 39, Narhe, Pune-411041, India
Department of Mechanical Engineering
ZEAL DRAG 2.0
2017- 2018



Dynamic Tests

BRAKE TEST

It was mandatory for a vehicle to pass the brake test to participate in any of the dynamic events. The brake test was conducted on 8m straight course of track with speed of 40km/hr while attempting brake test.

The vehicle must stop in a straight line after the brake is applied on the vehicle and the wheels on which the brake mechanism is acting must get locked immediately after pedal is pressed as well as break light must blink. Each vehicle was given only three attempts to pass the brake test. Vehicle dynamic stability was also checked during the test. Only two teams were disqualified in brake test.

Acceleration Test

The acceleration of the kart was evaluated during the brake test. Acceleration of the vehicle in attempt in which the vehicle is passing brake test was considered as final.

Autocross

The objective of the autocross event was to evaluate the vehicle's maneuverability and handling qualities on a tight course without the hindrance of competing vehicles. The autocross track was designed to evaluate combined performance features of acceleration, braking, and cornering ability.

Endurance

The Endurance Event was conducted on day 3. It was designed to evaluate the overall performance of the vehicle and to test the vehicle's reliability.

DEPARTMENT OF MECHANICAL ENGINEERING





Zeal Education Society's
ZEAL COLLEGE OF ENGINEERING AND RESEARCH
S.No. 39, Narhe, Pune-411041, India
Department of Mechanical Engineering
ZEAL DRAG 2.0
2017- 2018



Skid Pad

The objective of the skid-pad event was to measure the vehicle's cornering ability on a flat surface while making a constant-radius turn. The skid pad layout was a figure of 8

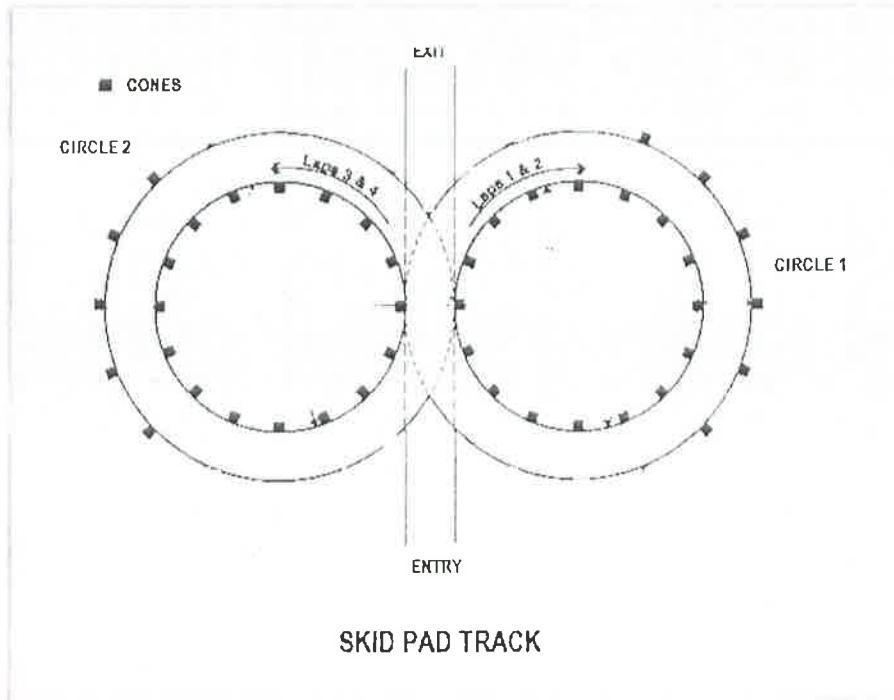

Drag Test

Drag racing is a type of motor racing in which karts compete, usually two at a time, to cross a set finish line. The race follows a short, straight course from a standing start over a measured distance. Electronic timing has been used to record race results. It was conducted on day 2 of the event.



DEPARTMENT OF MECHANICAL ENGINEERING



Zeal Education Society's
**ZEAL COLLEGE OF ENGINEERING AND
RESEARCH**

S.No. 39, Narhe, Pune-411041, India
Department of Mechanical Engineering

ZEAL DRAG 2.0

2017- 2018



GALLERY

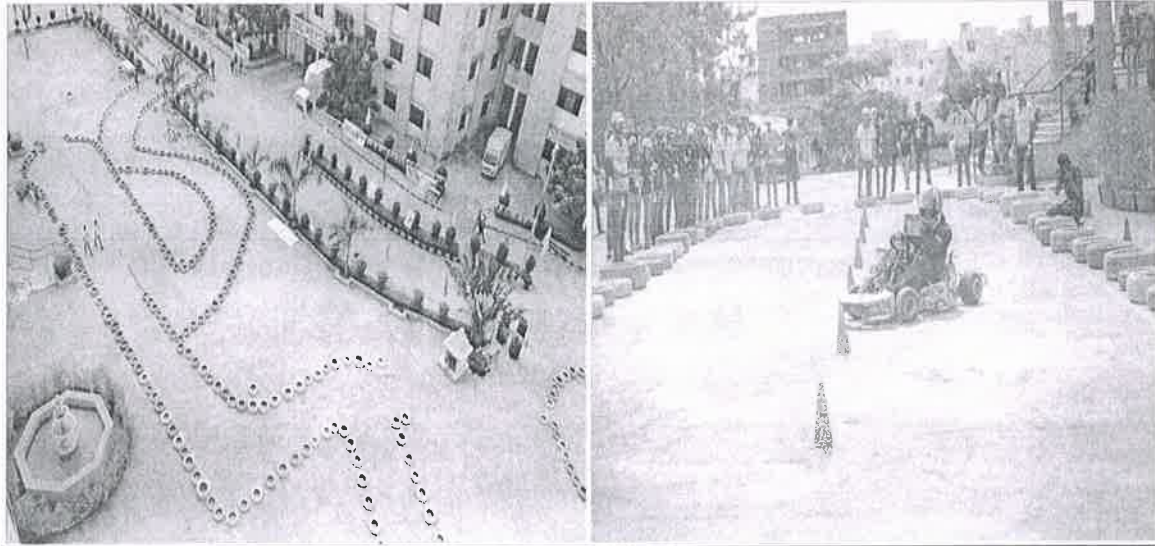

DEPARTMENT OF MECHANICAL ENGINEERING



Zeal Education Society's
ZEAL COLLEGE OF ENGINEERING AND RESEARCH
S.No. 39, Narhe, Pune-411041, India
Department of Mechanical Engineering
ZEAL DRAG 2.0
2017- 2018

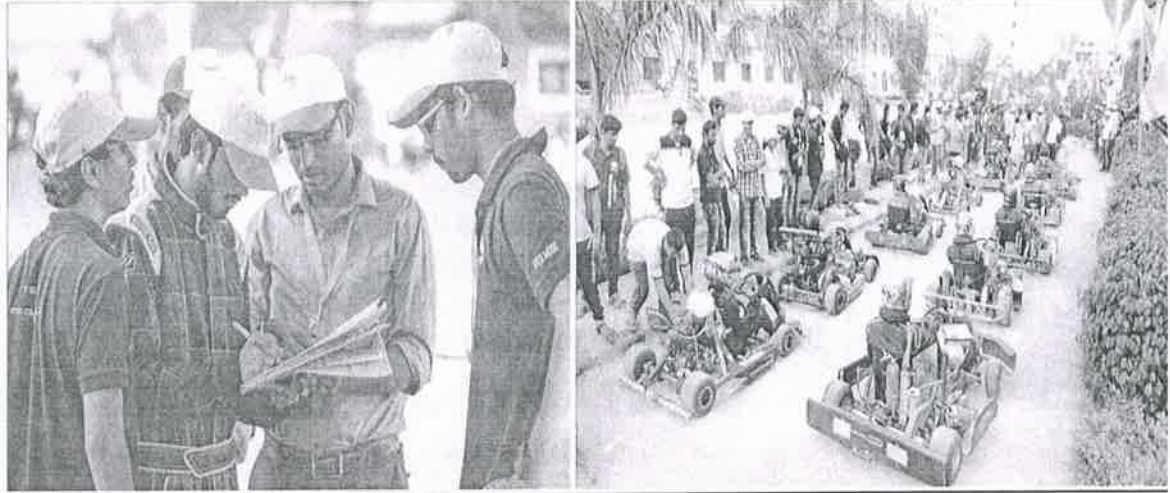

DEPARTMENT OF MECHANICAL ENGINEERING



Zeal Education Society's
**ZEAL COLLEGE OF ENGINEERING AND
RESEARCH**

S.No. 39, Narhe, Pune-411041, India
Department of Mechanical Engineering

ZEAL DRAG 2.0

2017- 2018

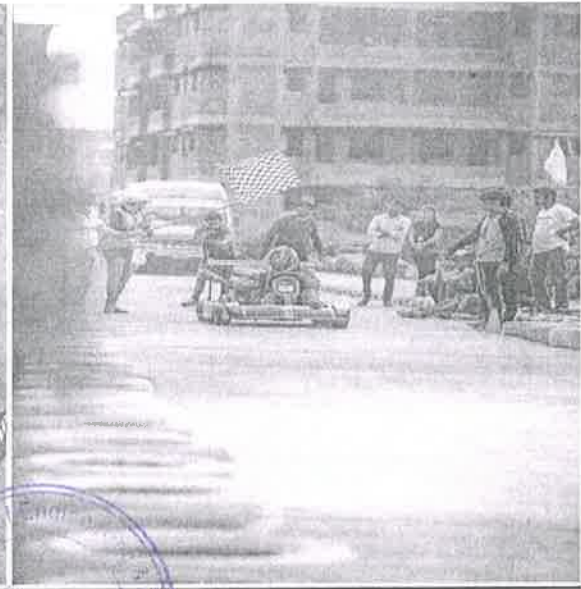
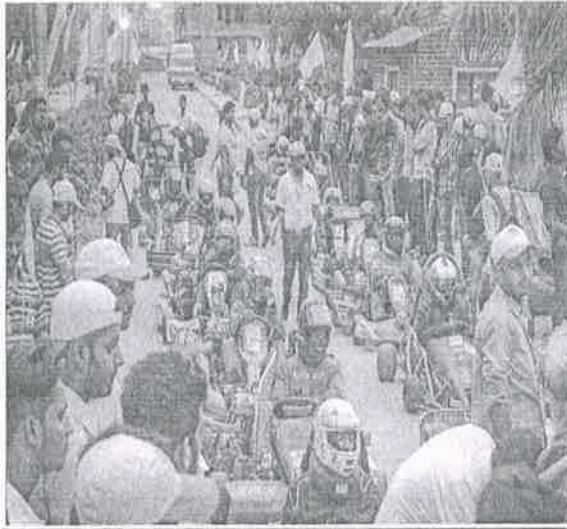

DEPARTMENT OF MECHANICAL ENGINEERING



Zeal Education Society's
**ZEAL COLLEGE OF ENGINEERING AND
RESEARCH**
S.No. 39, Narhe, Pune-411041, India
Department of Mechanical Engineering
ZEAL DRAG 2.0
2017- 2018



DEPARTMENT OF MECHANICAL ENGINEERING



Zeal Education Society's
**ZEAL COLLEGE OF ENGINEERING AND
RESEARCH**
S.No. 39, Narhe, Pune-411041, India
Department of Mechanical Engineering
ZEAL DRAG 2.0
2017- 2018



Organizing Committee

Akshay Karande	Contact Point Person, Event Management, Technical Committee & Rulebook
Pravin Parit	Contact Point Person, Event Management execution
Ajinkya Dawale	Dynamic events, Volunteer training
Omkar Kulkarni	Website and Social Media
Vikas Patil	Website Design & Update
Tausif Shaikh	VIP Relationship , Transport
Junaid Deshmukh	Secretary (Finance &Accounts)
Abhijit Kasar	Marketing,, Hotel ,Catering committee
Vitthal Randive	Event Registration Head.
Suhas Sawant	Endurance, Dynamic Event, Track Management & Safety
Sachin Godase	VIP Relationship ,Hospitality ,Guest Relationship



DEPARTMENT OF MECHANICAL ENGINEERING



Zeal Education Society's
**ZEAL COLLEGE OF ENGINEERING AND
RESEARCH**

S.No. 39, Narhe, Pune-411041, India
Department of Mechanical Engineering

ZEAL DRAG 2.0

2017- 2018



List of Volunteers

Sr.No	Volunteer No	Name	Class
1	ZD2.001	Neeraj Gole (TL)	TE
2	ZD2.002	Sagar Gondkar (TL)	TE
3	ZD2.003	Saurabh bharambe	TE
4	ZD2.004	Lokesh Harle	TE
5	ZD2.005	Shreyas Bhosale	TE
6	ZD2.006	Ghanashyam Jorwar	TE
7	ZD2.007	Yash Ghayal	TE
8	ZD2.008	Bharat Chougale	TE
9	ZD2.009	Akash kadam	TE
10	ZD2.010	Akhil Bhat	TE
11	ZD2.011	Rushikesh bade	TE
12	ZD2.012	Bhagat Prathamesh	TE
13	ZD2.013	Haris bagwan	TE
14	ZD2.014	Pritam Patil (TL)	S.E.-E
15	ZD2.015	Rahul Patil (TL)	S.E.-E
16	ZD2.016	Akshay Pashan	S.E.-E
17	ZD2.017	Prasad Kotkar	S.E.-E
18	ZD2.018	Suraj Nawale	S.E.-E
19	ZD2.019	Pratik Sawardekar	S.E.-E
20	ZD2.020	Pranav Lokhande	S.E.-E
21	ZD2.021	Manoj Wakde	S.E.-E
22	ZD2.022	Rohan Makhle	S.E.-E
23	ZD2.023	Vedant Talikhede	S.E.-E
24	ZD2.024	Survesh Bhele	S.E.-C
25	ZD2.025	Hardik Bhandare	S.E.-D
26	ZD2.026	Suraj Patil	B.E.-B
27	ZD2.027	Nilesh Shinde	S.E.-E
28	ZD2.028	Pravin Salunkhe	S.E.-E
29	ZD2.029	Gaurav Talekar	S.E.-E
30	ZD2.030	Sahil Gharat (TL)	TE

DEPARTMENT OF MECHANICAL ENGINEERING



Zeal Education Society's
**ZEAL COLLEGE OF ENGINEERING AND
RESEARCH**
S.No. 39, Narhe, Pune-411041, India
Department of Mechanical Engineering
ZEAL DRAG 2.0
2017- 2018



31	ZD2.031	Ritesh Gawali (TL)	TE
32	ZD2.032	Gautam Jahagirdar	TE
33	ZD2.033	Suyog Gosavi	TE
34	ZD2.034	Akhil Bhat	TE
35	ZD2.035	Rushikesh Bade	TE
36	ZD2.036	Abhishek Kulkarni	TE
37	ZD2.037	Pankaj Khot	TE
38	ZD2.038	Onkar Chapalgaonkar	TE
39	ZD2.039	Kaustubh Dixit	TE
40	ZD2.040	Akash Jeevan Divate	TE
41	ZD2.041	Chetan Chaudhari	TE
42	ZD2.042	Shubham Awasare	TE
43	ZD2.043	Vrushabh Desai	TE
44	ZD2.044	Nikhil Janave	TE
45	ZD2.045	Abhishek Shimpi	TE
46	ZD2.046	Pratik Talvar	TE
47	ZD2.047	Atish Katore	TE
48	ZD2.048	Siddhesh Shinde	TE
49	ZD2.049	Shashikant Gaikwad	TE
50	ZD2.050	Yadnesh Gulhane	TE

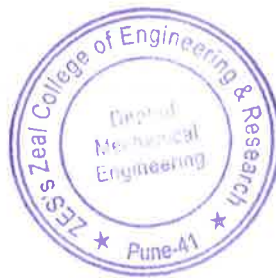

DEPARTMENT OF MECHANICAL ENGINEERING



Zeal Education Society's
**ZEAL COLLEGE OF ENGINEERING AND
RESEARCH**
S.No. 39, Narhe, Pune-411041, India
Department of Mechanical Engineering
ZEAL DRAG 2.0
2017- 2018



31	ZD2.031	Ritesh Gawali (TL)	TE
32	ZD2.032	Gautam Jahagirdar	TE
33	ZD2.033	Suyog Gosavi	TE
34	ZD2.034	Akhil Bhat	TE
35	ZD2.035	Rushikesh Bade	TE
36	ZD2.036	Abhishek Kulkarni	TE
37	ZD2.037	Pankaj Khot	TE
38	ZD2.038	Onkar Chapalgaonkar	TE
39	ZD2.039	Kaustubh Dixit	TE
40	ZD2.040	Akash Jeevan Divate	TE
41	ZD2.041	Chetan Chaudhari	TE
42	ZD2.042	Shubham Awasare	TE
43	ZD2.043	Vrushabh Desai	TE
44	ZD2.044	Nikhil Janave	TE
45	ZD2.045	Abhishek Shimpi	TE
46	ZD2.046	Pratik Talvar	TE
47	ZD2.047	Atish Katore	TE
48	ZD2.048	Siddhesh Shinde	TE
49	ZD2.049	Shashikant Gaikwad	TE
50	ZD2.050	Yadnesh Gulhane	TE

Head Of Department
Mechanical Engineering

DEPARTMENT OF MECHANICAL ENGINEERING



ZEAL EDUCATION SOCIETY'S
ZEAL COLLEGE OF ENGINEERING AND RESEARCH, NARHE, PUNE
DEPARTMENT OF MECHANICAL ENGINEERING



MESA Sports League

2018-2019

RULES & GUIDELINES FOR CRICKET

- All teams have to submit team registration form duly signed by the team captain on or before 16/01/2019.
- Each team must register total 15 players (11-Playing & 4-Extra).
- Only registered will be allowed to play the matches.
- Each inning will be of total 8 Overs.
- Team must report to the ground 20 minutes before scheduled match. Failing to report on the ground on scheduled time will result in forfeit of the match i.e. opponent will be given bye.
- Match will not be rescheduled in any circumstances.
- Match will be played using a cricket tennis ball.
- Tournament is organized on a knock out basis
- Unruly behavior by the team players or its supporters shall lead to disqualification from the tournament.
- Umpires decision will be final in all aspects pertaining to the games.

Team 12



ZEAL EDUCATION SOCIETY'S
ZEAL COLLEGE OF ENGINEERING AND RESEARCH, NARHE, PUNE
DEPARTMENT OF MECHANICAL ENGINEERING



MESA Sports League

2018-2019

Cricket Team Registration form

Team Name	BE-B 1
Class & Division	BE-B
Captains Name	
Captains Phone Number	

Players Details

Sr. No.	Name of the Player (In Capital Letters only)	Roll Number	Sr. No.	Name of the Player (In Capital Letters only)	Roll Number
1	KAMBLE SAGAR	B51091	9	KUTE RAMESHWAR D	B51107
2	KARAD D. G.	B51092	10	KUMBHAR ROHAN A	B51102
3	KHOT PANKAJ H	B51095	11	KULKARNI ABHI V.	B51100
4	KULE AJINKYA R	B51098	12		
5	KADAM AKASH S	B51086	13		
6	KOKATE K. S.	B51096	14		
7	KUTE AJAY T	B51103	15		
8	LOHAR S. S.				



Captain Signature



ZEAL EDUCATION SOCIETY'S
ZEAL COLLEGE OF ENGINEERING AND RESEARCH, NARHE, PUNE
DEPARTMENT OF MECHANICAL ENGINEERING



MESA Sports League

2018-2019

RULES & GUIDELINES FOR CRICKET

- All teams have to submit team registration form duly signed by the team captain on or before 16/01/2019.
- Each team must register total 15 players (11-Playing & 4-Extra).
- Only registered will be allowed to play the matches.
- Each inning will be of total 8 Overs.
- Team must report to the ground 20 minutes before scheduled match. Failing to report on the ground on scheduled time will result in forfeit of the match i.e. opponent will be given bye.
- Match will not be rescheduled in any circumstances.
- Match will be played using a cricket tennis ball.
- Tournament is organized on a knock out basis
- Unruly behavior by the team players or its supporters shall lead to disqualification from the tournament.
- Umpires decision will be final in all aspects pertaining to the games.



ZEAL EDUCATION SOCIETY'S
ZEAL COLLEGE OF ENGINEERING AND RESEARCH, NARHE, PUNE
DEPARTMENT OF MECHANICAL ENGINEERING

Team 11



MESA Sports League 2018-2019

Cricket Team Registration form

Team Name	
Class & Division	B.E - A
Captains Name	BANKAR DIPAK
Captains Phone Number	

Players Details

Sr. No.	Name of the Player (In Capital Letters only)	Roll Number	Sr. No.	Name of the Player (In Capital Letters only)	Roll Number
1	BANKAR DIPAK	B51005	9	GOLE NEERAJ P	B51058
2	BHAT AKHIL S	B51011	10	GOSAVI SUYOG V	B51060
3	BORADE FEJAS K	B51019	11	HALE ABHISHEK A	B51066.
4	CHAVAN AMRUT U	B51024	12		
5	DALVI RUSHIKESH	B51032	13		
6	BORBALE SHRI KRISHNA	B51020	14		
7	GHAYAL YASH S	B51055	15		
8	GAWAI SHUBHAM S.	B51052			

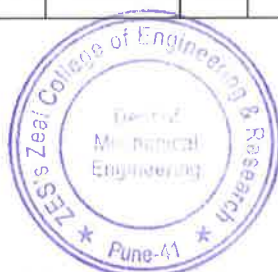

Captain Signature



**ZEAL EDUCATION SOCIETY'S
ZEAL COLLEGE OF ENGINEERING AND RESEARCH, NARHE, PUNE
DEPARTMENT OF MECHANICAL ENGINEERING**



MESA Sports League

2018-2019

RULES & GUIDELINES FOR CRICKET

- All teams have to submit team registration form duly signed by the team captain on or before 16/01/2019.
- Each team must register total 15 players (11-Playing & 4-Extra).
- Only registered will be allowed to play the matches.
- Each inning will be of total 8 Overs.
- Team must report to the ground 20 minutes before scheduled match. Failing to report on the ground on scheduled time will result in forfeit of the match i.e. opponent will be given bye.
- Match will not be rescheduled in any circumstances.
- Match will be played using a cricket tennis ball.
- Tournament is organized on a knock out basis
- Unruly behavior by the team players or its supporters shall lead to disqualification from the tournament.
- Umpires decision will be final in all aspects pertaining to the games.

Team 10



ZEAL EDUCATION SOCIETY'S
ZEAL COLLEGE OF ENGINEERING AND RESEARCH, NARHE, PUNE
DEPARTMENT OF MECHANICAL ENGINEERING



MESA Sports League

2018-2019

Cricket Team Registration form

Team Name	
Class & Division	TE - E
Captains Name	
Captains Phone Number	

Players Details

Sr. No.	Name of the Player (In Capital Letters only)	Roll Number	Sr. No.	Name of the Player (In Capital Letters only)	Roll Number
1	MAHADIK ASHISH D	TS2068	9	PATIL PRITAM S	TS2087
2	MAYHALE ROHAN B	TS2069	10	PATIL RAHUL RAMRAO	TS2089
3	MALI NIKHIL P	TS2070	11	PATIL SURAJ S	TS2092
4	MORE NISHANT S	TS2071	12		
5	MOTE DINESH K	TS2072	13		
6	NAVALE SURAJ J	TS2076	14		
7	PALANGE VINAYAK A	TS2078	15		
8	PATIL AKBHAY TANAJI	TS2083			



Captain Signature



**ZEAL EDUCATION SOCIETY'S
ZEAL COLLEGE OF ENGINEERING AND RESEARCH, NARHE, PUNE
DEPARTMENT OF MECHANICAL ENGINEERING**



MESA Sports League

2018-2019

RULES & GUIDELINES FOR CRICKET

- All teams have to submit team registration form duly signed by the team captain on or before 16/01/2019.
- Each team must register total 15 players (11-Playing & 4-Extra).
- Only registered will be allowed to play the matches.
- Each inning will be of total 8 Overs.
- Team must report to the ground 20 minutes before scheduled match. Failing to report on the ground on scheduled time will result in forfeit of the match i.e. opponent will be given bye.
- Match will not be rescheduled in any circumstances.
- Match will be played using a cricket tennis ball.
- Tournament is organized on a knock out basis
- Unruly behavior by the team players or its supporters shall lead to disqualification from the tournament.
- Umpires decision will be final in all aspects pertaining to the games.



ZEAL EDUCATION SOCIETY'S
ZEAL COLLEGE OF ENGINEERING AND RESEARCH, NARHE, PUNE
DEPARTMENT OF MECHANICAL ENGINEERING



MESA Sports League

2018-2019

Team 9

Cricket Team Registration form

Team Name	
Class & Division	TE-D
Captains Name	
Captains Phone Number	

Players Details

Sr. No.	Name of the Player (In Capital Letters only)	Roll Number	Sr. No.	Name of the Player (In Capital Letters only)	Roll Number
1	BANGUL CHETAN D	T52002	9	DIXIT NIKHIL K	T52026
2	BHAGADE SAGAR V	T52004	10	GARUD VIVEK V	T52031
3	BHOLE TEJAS S	T52006	11	GAWADE AMIT L	T52032
4	BORADE YOGESH L	T52009	12		
5	CHENDAKE AMEY D	T52012	13		
6	GHOUGALE TANMAY A	T52016	14		
7	DAVLE ASHUTOSH J	T52018	15		
8	DESAI KRISHNA G	T52020			



Captain Signature



ZEAL EDUCATION SOCIETY'S
ZEAL COLLEGE OF ENGINEERING AND RESEARCH, NARHE, PUNE
DEPARTMENT OF MECHANICAL ENGINEERING



MESA Sports League

2018-2019

RULES & GUIDELINES FOR CRICKET

- All teams have to submit team registration form duly signed by the team captain on or before 16/01/2019.
- Each team must register total 15 players (11-Playing & 4-Extra).
- Only registered will be allowed to play the matches.
- Each inning will be of total 8 Overs.
- Team must report to the ground 20 minutes before scheduled match. Failing to report on the ground on scheduled time will result in forfeit of the match i.e. opponent will be given bye.
- Match will not be rescheduled in any circumstances.
- Match will be played using a cricket tennis ball.
- Tournament is organized on a knock out basis
- Unruly behavior by the team players or its supporters shall lead to disqualification from the tournament.
- Umpires decision will be final in all aspects pertaining to the games.



ZEAL EDUCATION SOCIETY'S
ZEAL COLLEGE OF ENGINEERING AND RESEARCH, NARHE, PUNE
DEPARTMENT OF MECHANICAL ENGINEERING



MESA Sports League

2018-2019

Team 8

Cricket Team Registration form

Team Name	
Class & Division	TE-C
Captains Name	
Captains Phone Number	

Players Details

Sr. No.	Name of the Player (In Capital Letters only)	Roll Number	Sr. No.	Name of the Player (In Capital Letters only)	Roll Number
1	NELESH CHAVRE	T51018	9	BARDA NIRAJ P	T51158
2	PANKAJ KADU	T51082	10	SATHE SHRISH D	T51159
3	PATIL GIRISH A	T51138	11	SAWIKAR ANUS N	T51163
4	PATIL KALPESH D	T51139	12		
5	PIDURKAR SURAJ D	T51145	13		
6	RANDIVE SHUBHAM	T51180	14		
7	RAUT SANJAY S	T51153	15		
8	SANAS ABHISHEK	T51155			



Captain Signature



**ZEAL EDUCATION SOCIETY'S
ZEAL COLLEGE OF ENGINEERING AND RESEARCH, NARHE, PUNE
DEPARTMENT OF MECHANICAL ENGINEERING**



MESA Sports League

2018-2019

RULES & GUIDELINES FOR CRICKET

- All teams have to submit team registration form duly signed by the team captain on or before 16/01/2019.
- Each team must register total 15 players (11-Playing & 4-Extra).
- Only registered will be allowed to play the matches.
- Each inning will be of total 8 Overs.
- Team must report to the ground 20 minutes before scheduled match. Failing to report on the ground on scheduled time will result in forfeit of the match i.e. opponent will be given bye.
- Match will not be rescheduled in any circumstances.
- Match will be played using a cricket tennis ball.
- Tournament is organized on a knock out basis
- Unruly behavior by the team players or its supporters shall lead to disqualification from the tournament.
- Umpires decision will be final in all aspects pertaining to the games.



ZEAL EDUCATION SOCIETY'S
ZEAL COLLEGE OF ENGINEERING AND RESEARCH, NARHE, PUNE
DEPARTMENT OF MECHANICAL ENGINEERING



MESA Sports League

2018-2019

Team 7

Cricket Team Registration form

Team Name	
Class & Division	TE - B
Captains Name	
Captains Phone Number	

Players Details

Sr. No.	Name of the Player (In Capital Letters only)	Roll Number	Sr. No.	Name of the Player (In Capital Letters only)	Roll Number
1	JADHAV PRAKASH P	TS1065	9	KASBE AKASH D	TS1088
2	JADHAV TUSHAR R	TS1069	10	KATE SWAPNIL C	TS1089
3	JANGAM DARSHAN S	TS1071	11	KOLHE AMIT B	TS1095
4	JOSHI OMKAR B	TS1074	12		
5	JOSHI ROHIT S	TS1075	13		
6	KADAM GAJANAN A	TS1080	14		
7	KADLAG MOHIT R	TS1081	15		
8	KALE SWAPNIL R	TS1084			



Captain Signature



ZEAL EDUCATION SOCIETY'S
ZEAL COLLEGE OF ENGINEERING AND RESEARCH, NARHE, PUNE
DEPARTMENT OF MECHANICAL ENGINEERING



MESA Sports League

2018-2019

RULES & GUIDELINES FOR CRICKET

- All teams have to submit team registration form duly signed by the team captain on or before 16/01/2019.
- Each team must register total 15 players (11-Playing & 4-Extra).
- Only registered will be allowed to play the matches.
- Each inning will be of total 8 Overs.
- Team must report to the ground 20 minutes before scheduled match. Failing to report on the ground on scheduled time will result in forfeit of the match i.e. opponent will be given bye.
- Match will not be rescheduled in any circumstances.
- Match will be played using a cricket tennis ball.
- Tournament is organized on a knock out basis
- Unruly behavior by the team players or its supporters shall lead to disqualification from the tournament.
- Umpires decision will be final in all aspects pertaining to the games.



ZEAL EDUCATION SOCIETY'S
ZEAL COLLEGE OF ENGINEERING AND RESEARCH, NARHE, PUNE
DEPARTMENT OF MECHANICAL ENGINEERING



MESA Sports League

2018-2019

Team 6

Cricket Team Registration form

Team Name	
Class & Division	TE - A
Captains Name	
Captains Phone Number	

Players Details

Sr. No.	Name of the Player (In Capital Letters only)	Roll Number	Sr. No.	Name of the Player (In Capital Letters only)	Roll Number
1	AMLE SHRIPAD	TS1002	9	CHITTE VIKANT BHARAT	TS1024
2	AYWALE SAGAR	TS1003	10	DAHARE SHUBHAM SANTOSH	TS1030
3	BASKAR SHANTANU APPA	TS1005	11	DAMLE VIJAY VINAY	TS1031
4	BANDAL VISHWAKESH	TS1008	12		
5	BHOJTE ASINKYA GIRISH	TS1011	13		
6	BYARI MUNDER MOHIN	TS1015	14		
7	CHAVAN NAYNATH BAPU	TS1016	15		
8	CHAVAN SANKET SANJAY	TS1017			



Captain Signature



ZEAL EDUCATION SOCIETY'S
ZEAL COLLEGE OF ENGINEERING AND RESEARCH, NARHE, PUNE
DEPARTMENT OF MECHANICAL ENGINEERING



MESA Sports League

2018-2019

RULES & GUIDELINES FOR CRICKET

- All teams have to submit team registration form duly signed by the team captain on or before 16/01/2019.
- Each team must register total 15 players (11-Playing & 4-Extra).
- Only registered will be allowed to play the matches.
- Each inning will be of total 8 Overs.
- Team must report to the ground 20 minutes before scheduled match. Failing to report on the ground on scheduled time will result in forfeit of the match i.e. opponent will be given bye.
- Match will not be rescheduled in any circumstances.
- Match will be played using a cricket tennis ball.
- Tournament is organized on a knock out basis
- Unruly behavior by the team players or its supporters shall lead to disqualification from the tournament.
- Umpires decision will be final in all aspects pertaining to the games.



ZEAL EDUCATION SOCIETY'S
ZEAL COLLEGE OF ENGINEERING AND RESEARCH, NARHE, PUNE
DEPARTMENT OF MECHANICAL ENGINEERING



MESA Sports League

2018-2019

Team (5)

Cricket Team Registration form

Team Name	
Class & Division	SE - E
Captains Name	
Captains Phone Number	

Players Details

Sr. No.	Name of the Player (In Capital Letters only)	Roll Number	Sr. No.	Name of the Player (In Capital Letters only)	Roll Number
1	KULKARNI RUSHIKESH	552046	9	SHINDE PRANAY JAGDISH	552068
2	KULKARNI YOGESH	552047	10	SINGH MOHIT SOBAN	552069
3	PATIL YOGESH PRABHAKAR	552050	11	VARE PANKAJ SUNIL	552074
4	MORE MAHESH SANJAY	552053	12		
5	PATIL SHUBHAM RAVINDRA	552055	13		
6	POLSURAJ BALASO	552058	14		
7	RAUT ANKUR	552059	15		
8	SALI VINAYAK UMESH	552061			



Captain Signature



**ZEAL EDUCATION SOCIETY'S
ZEAL COLLEGE OF ENGINEERING AND RESEARCH, NARHE, PUNE
DEPARTMENT OF MECHANICAL ENGINEERING**



MESA Sports League

2018-2019

RULES & GUIDELINES FOR CRICKET

- All teams have to submit team registration form duly signed by the team captain on or before 16/01/2019.
- Each team must register total 15 players (11-Playing & 4-Extra).
- Only registered will be allowed to play the matches.
- Each inning will be of total 8 Overs.
- Team must report to the ground 20 minutes before scheduled match. Failing to report on the ground on scheduled time will result in forfeit of the match i.e. opponent will be given bye.
- Match will not be rescheduled in any circumstances.
- Match will be played using a cricket tennis ball.
- Tournament is organized on a knock out basis
- Unruly behavior by the team players or its supporters shall lead to disqualification from the tournament.
- Umpires decision will be final in all aspects pertaining to the games.

Team (4)



ZEAL EDUCATION SOCIETY'S
ZEAL COLLEGE OF ENGINEERING AND RESEARCH, NARHE, PUNE
DEPARTMENT OF MECHANICAL ENGINEERING



MESA Sports League

2018-2019

Cricket Team Registration form

Team Name	
Class & Division	SE - D
Captains Name	
Captains Phone Number	

Players Details

Sr. No.	Name of the Player (In Capital Letters only)	Roll Number	Sr. No.	Name of the Player (In Capital Letters only)	Roll Number
1	ANGADI GANESH MANDHAR	552001	9	MOGHE KANAK GIRISH	552016
2	BANDALE TEJAS	552003	10	PATIL RUSHIKESH SANJAY	552017
3	BORATE MAYURESH	552005	11	TATHE SAURABH	552020
4	CHAUDHARI ANIRUDDHA	552007	12	DALVI SAHIL SUDHIR	552033
5	GAWADE SUHAS SHANKAR	552009	13	DESAI ABHISHEKH BHAGWAT	552034
6	JADHAV PRAKASH PRAKASH	552011	14	DIXIT AKHILESH GAJANAN	552037
7	LOKHRE BHAGWAN VISHNU	552013	15	DOMBE AKSHAY GANGADHAR	552038
8	MALIS AVDHUT SANDEEP	552015			



Captain Signature



ZEAL EDUCATION SOCIETY'S
ZEAL COLLEGE OF ENGINEERING AND RESEARCH, NARHE, PUNE
DEPARTMENT OF MECHANICAL ENGINEERING



MESA Sports League

2018-2019

RULES & GUIDELINES FOR CRICKET

- All teams have to submit team registration form duly signed by the team captain on or before 16/01/2019.
- Each team must register total 15 players (11-Playing & 4-Extra).
- Only registered will be allowed to play the matches.
- Each inning will be of total 8 Overs.
- Team must report to the ground 20 minutes before scheduled match. Failing to report on the ground on scheduled time will result in forfeit of the match i.e. opponent will be given bye.
- Match will not be rescheduled in any circumstances.
- Match will be played using a cricket tennis ball.
- Tournament is organized on a knock out basis
- Unruly behavior by the team players or its supporters shall lead to disqualification from the tournament.
- Umpires decision will be final in all aspects pertaining to the games.

Team 3



ZEAL EDUCATION SOCIETY'S
ZEAL COLLEGE OF ENGINEERING AND RESEARCH, NARHE, PUNE
DEPARTMENT OF MECHANICAL ENGINEERING



MESA Sports League 2018-2019

Cricket Team Registration form

Team Name	
Class & Division	SE - C
Captains Name	
Captains Phone Number	

Players Details

Sr. No.	Name of the Player (In Capital Letters only)	Roll Number	Sr. No.	Name of the Player (In Capital Letters only)	Roll Number
1	MAHALIM GAURAV VIJAY	551139	9	SALUNKE PRANAY SANTAY	551167
2	MAJID SIDDHESH DEEPAK	551140	10	SAYKAD SOHEL	551171
3	MANE SAURABH POPAT	551142	11	SHEWALE SAGAR SANTAY	551173
4	MOHOL OMKAR ANIL	551144	12	RATHE SAHEL DINESH	551164
5	MORE OMKAR DNYANUBA	551146	13	POTTE DEVIKANTH YOGESH	551162
6	MORE PAWAN BALAJI	551147	14	PASALKAR ATHARVA	551155
7	NALAWADE AJIT GORAKH	551150	15	PARDESI RUSHIKESH	551154
8	PATIL ANIRUDDHA MALHAR	551156			



Captain Signature



**ZEAL EDUCATION SOCIETY'S
ZEAL COLLEGE OF ENGINEERING AND RESEARCH, NARHE, PUNE
DEPARTMENT OF MECHANICAL ENGINEERING**



MESA Sports League

2018-2019

RULES & GUIDELINES FOR CRICKET

- All teams have to submit team registration form duly signed by the team captain on or before 16/01/2019.
- Each team must register total 15 players (11-Playing & 4-Extra).
- Only registered will be allowed to play the matches.
- Each inning will be of total 8 Overs.
- Team must report to the ground 20 minutes before scheduled match. Failing to report on the ground on scheduled time will result in forfeit of the match i.e. opponent will be given bye.
- Match will not be rescheduled in any circumstances.
- Match will be played using a cricket tennis ball.
- Tournament is organized on a knock out basis
- Unruly behavior by the team players or its supporters shall lead to disqualification from the tournament.
- Umpires decision will be final in all aspects pertaining to the games.



ZEAL EDUCATION SOCIETY'S
ZEAL COLLEGE OF ENGINEERING AND RESEARCH, NARHE, PUNE
DEPARTMENT OF MECHANICAL ENGINEERING



MESA Sports League

2018-2019

Team (2)

Cricket Team Registration form

Team Name	
Class & Division	SE-B
Captains Name	
Captains Phone Number	

Players Details

Sr. No.	Name of the Player (In Capital Letters only)	Roll Number	Sr. No.	Name of the Player (In Capital Letters only)	Roll Number
1	AVHAD SAURABH SHANKAR	551081	9	DEORE MAYUR UTTAM	551103
2	BABAR SHUBHAM PRADEEP	551082	10	DHOLE PRANAY RAJENDRA	551105
3	BHAT TANMAY SURESH	551087	11	DHOTRE ANKET LAXMAN	551108
4	SAPTHAR BODAKE SWAPNIL JANAJI	551091	12	GHARVE PRANIT SAMIR	551112
5	BODKE GAURAV LAHU	551092	13	INGOLE AAKASH MARUTI	551114
6	BORSE NILESH SHIVRAM	551095	14	JADHAV GANESH BALAJI	551116
7	CHAPKE SHEKHAR MANOJ	551097	15	JAGTAP PRATSK BALASO	551120
8	CHAVAN AADESH RAJENDRA	551098			



Captain Signature



ZEAL EDUCATION SOCIETY'S
ZEAL COLLEGE OF ENGINEERING AND RESEARCH, NARHE, PUNE
DEPARTMENT OF MECHANICAL ENGINEERING



MESA Sports League

2018-2019

RULES & GUIDELINES FOR CRICKET

- All teams have to submit team registration form duly signed by the team captain on or before 16/01/2019.
- Each team must register total 15 players (11-Playing & 4-Extra).
- Only registered will be allowed to play the matches.
- Each inning will be of total 8 Overs.
- Team must report to the ground 20 minutes before scheduled match. Failing to report on the ground on scheduled time will result in forfeit of the match i.e. opponent will be given bye.
- Match will not be rescheduled in any circumstances.
- Match will be played using a cricket tennis ball.
- Tournament is organized on a knock out basis
- Unruly behavior by the team players or its supporters shall lead to disqualification from the tournament.
- Umpires decision will be final in all aspects pertaining to the games.



ZEAL EDUCATION SOCIETY'S
ZEAL COLLEGE OF ENGINEERING AND RESEARCH, NARHE, PUNE
DEPARTMENT OF MECHANICAL ENGINEERING



MESA Sports League

2018-2019

Team 1

Cricket Team Registration form

Team Name	
Class & Division	SE-A
Captains Name	KARALE AKASH
Captains Phone Number	8421290634

Players Details

Sr. No.	Name of the Player (In Capital Letters only)	Roll Number	Sr. No.	Name of the Player (In Capital Letters only)	Roll Number
1	ACHOLI ANIL	551001	9	KARALE AKASH SHIVAJI	551032
2	BIDVE ABHJIT SUNIL	551006	10	KARALE SHARMA HRIK	551065
3	BORKAR SANKET UMESH	551008	11	SHENDE AMOL SANJAY	551066
4	BOROLE ROHAN SUNIL	551009	12	SHIRKE VIVEK DILIP	551067
5	DHOBLE MARUTI RAM	551018	13	UBHE NIKHIL SAKHARAM	551072
6	JADHAV OMKAR HARISH	551026	14	YADAV ABHISHEK SHIVAJI	551075
7	JADHAV SARTHAK KISHOR	551027	15	YADAV SURAJ JAYRAM	551077
8	KAMBLE ABHUTOSH NANDU	551031			



Captain Signature

* Chess Lots *

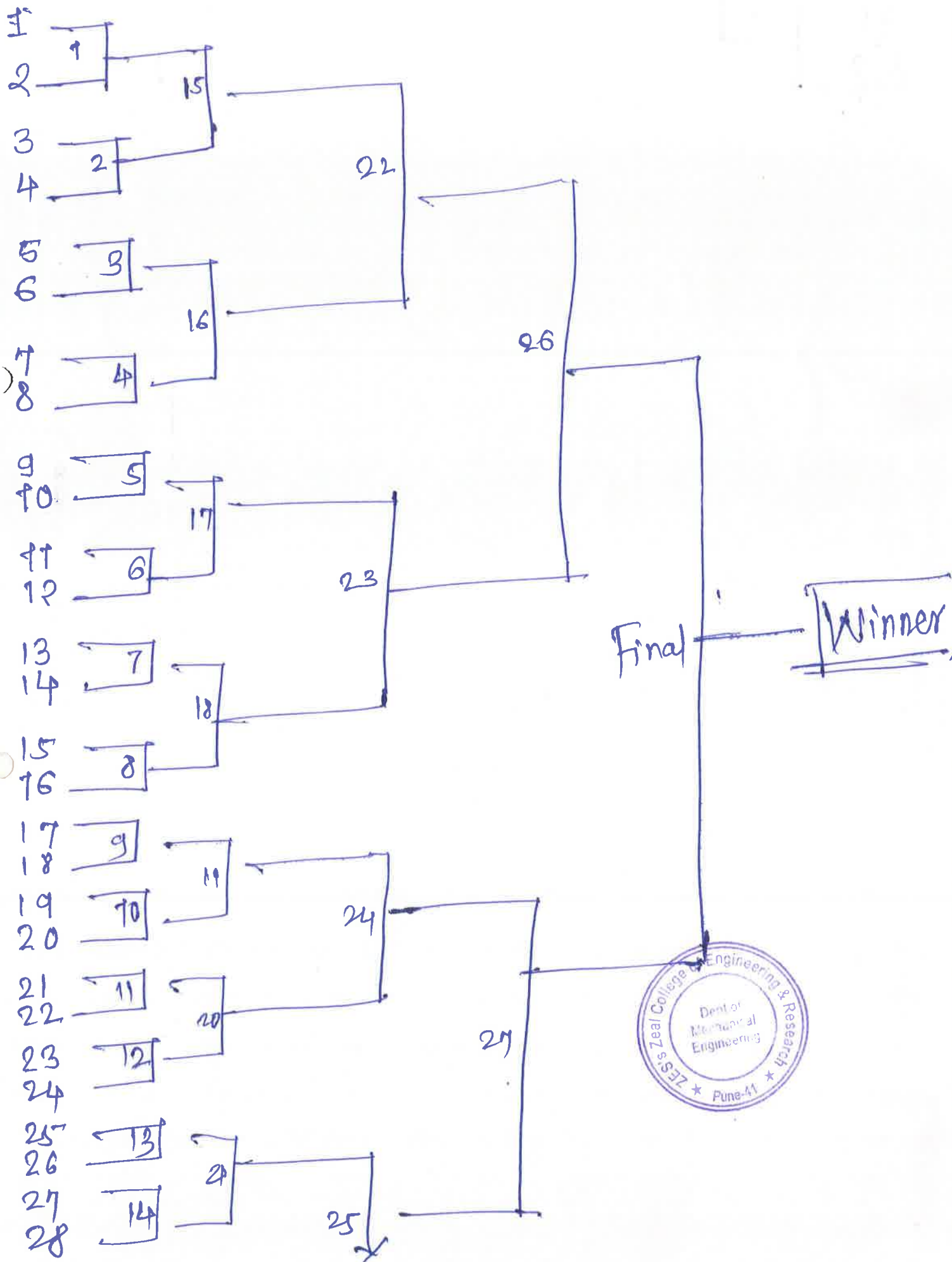

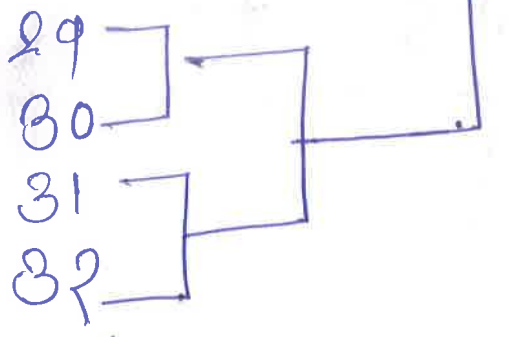



ZEAL EDUCATION SOCIETY'S
ZEAL COLLEGE OF ENGINEERING AND RESEARCH, NARHE, PUNE
DEPARTMENT OF MECHANICAL ENGINEERING



MESA Sports League

2018-2019

Chess Competition Registration sheet

Sr. No.	Class & Division	Roll Number	Name of the Player	Sign
16	SE B	SS1088	Bhatkar Priyal	
17	SE A	SS1035	Kharabe Vaishnavi	
18	SE A	SS1032	Karale Akash.	
19	TE B	T51094	Khedkar Praywal	
20	TE-C	T51157	Sarade Prashant S.	
21	TE C	T51168	Shimpi Aman	
22	TE-C	T51166	Shende Prithvi R	
23	TE D	T52039	Hapse Sourabh	
24	BE-A	B51034	Darade Prakash P	
25	BE-B	B51108	Lakhpati Keshav S	
26	TE D	T52004	Bhagade Sagar	
27	TE C	T51167	Shete Rohit	
28	SE-C	SS1174	Shid Rohit B.	
29	SE-E	SS2051	Mate Kunal Khandu	
30	SE-E	SS2053	More Mahesh Sanjay	

31 SE-E SS2055 Patil Shubham Rajendra

32 SE-E SS2058 Patil Suraj Balasa





ZEAL EDUCATION SOCIETY'S
ZEAL COLLEGE OF ENGINEERING AND RESEARCH, NARHE, PUNE
DEPARTMENT OF MECHANICAL ENGINEERING



MESA Sports League

2018-2019

Chess Competition Registration sheet

Sr. No.	Class & Division	Roll Number	Name of the Player	Sign
1	TEA	T51022	Chourge Rituraj	
2	SE-E	S52065	Shilimkar Dnyaneshwar B.	
3	BEA	T51021	chandrate Meeraj	
4	SE-C	S51197	Dakhore Yashvant V.	
5	TEB	T51101	Kumdallekar sejat	
6	SE-E	S52072	Tanzil Ahemad M	
7	SE-D	S52044	Kerke Nishant. C.	
8	TEA	T51011	Bhote Ajinkya	
9	TE E	T52093	Patil Tejas	
10	BEA	T51018	Bhosale Shreyas	
11	SE-D	S52045	Khedkar Akshay P.	
12	TEA	T51024	Chordia Akshay	
13	SEE	S52025	Ambekar Arthav.	
14	BE B	B51111	Mahajan Madhura.	
15	TE E	T52103	Salunkhe Pravin.	



Handwritten text at the top of the page, possibly a title or header.

M. ... list ... + ...
C. ...

Handwritten text in the middle section of the page.

Handwritten text at the bottom of the page.



ZEAL EDUCATION SOCIETY'S
ZEAL COLLEGE OF ENGINEERING AND RESEARCH, NARHE, PUNE
DEPARTMENT OF MECHANICAL ENGINEERING



MESA Sports League

2018-2019

Carrom Competition Registration sheet

Sr. No.	Class & Division	Roll Number	Name of the Player	Sign
1	SE-D	S52004	Bhojane Rutwik A.	
2	SF-E	S52059	Raut Ankur.	
3	TE-D	T52013	Chirmade Sumit S.	
4	SE-C	S51145	More Kajal P.	
5	S.E-A	S51017	Dhakane Dnyaneshwar A.	
6	SE-B	S51088	Bhatkar Priyal S.	
7	SE-C	S51159	phalke Prasanna S.	
8	TE-C	T51163	Sawkar Anuj N.	
9	TE-D	T52020	Desai Krishna G.	
10	S.E-B.	S51112	Ghame Pranit S.	
11	SE-A	S51025	Hajase Arshay V.	
12	SE-D	S52026	Ayade Vedant M.	
13				
14				
15				

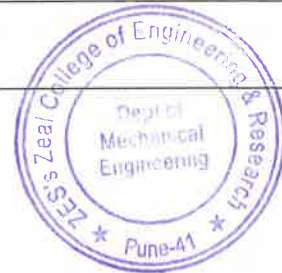



MESA Sports League

2018-2019

Carrom Competition Registration sheet

Sr. No.	Class & Division	Roll Number	Name of the Player	Sign
13	BE-E	B52077	Kokare Abhimanyu R	
14	TE-B	T51084	Kale Swapnil. R	
15	TE-A	T51020	Chirme Pratik J.	
16	TE-C	T51082	Kadu Pankaj	
17	TE-C	T51148	Raikar Akshay S.	
18	T.E-D	T52027	Dudhabhate Sagar Kumar	
19	T.E-E	T52073	Mulik Pankaj S.	
20	BE-E	B52101	Pawar Pranay S.	
21	TE-E	T52091	Patil Shubham V.	
22	TE-C	T51157	Patil Pooja N.	
23	T.E-A	T51189	Bhat Kapil K.	
24	TE-B	T51121	More Shubham R.	
13				
14				
15				

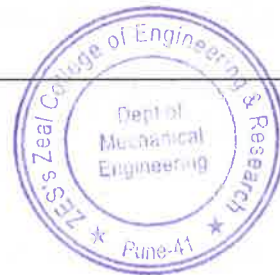

Carrom Lots

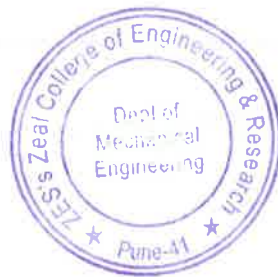
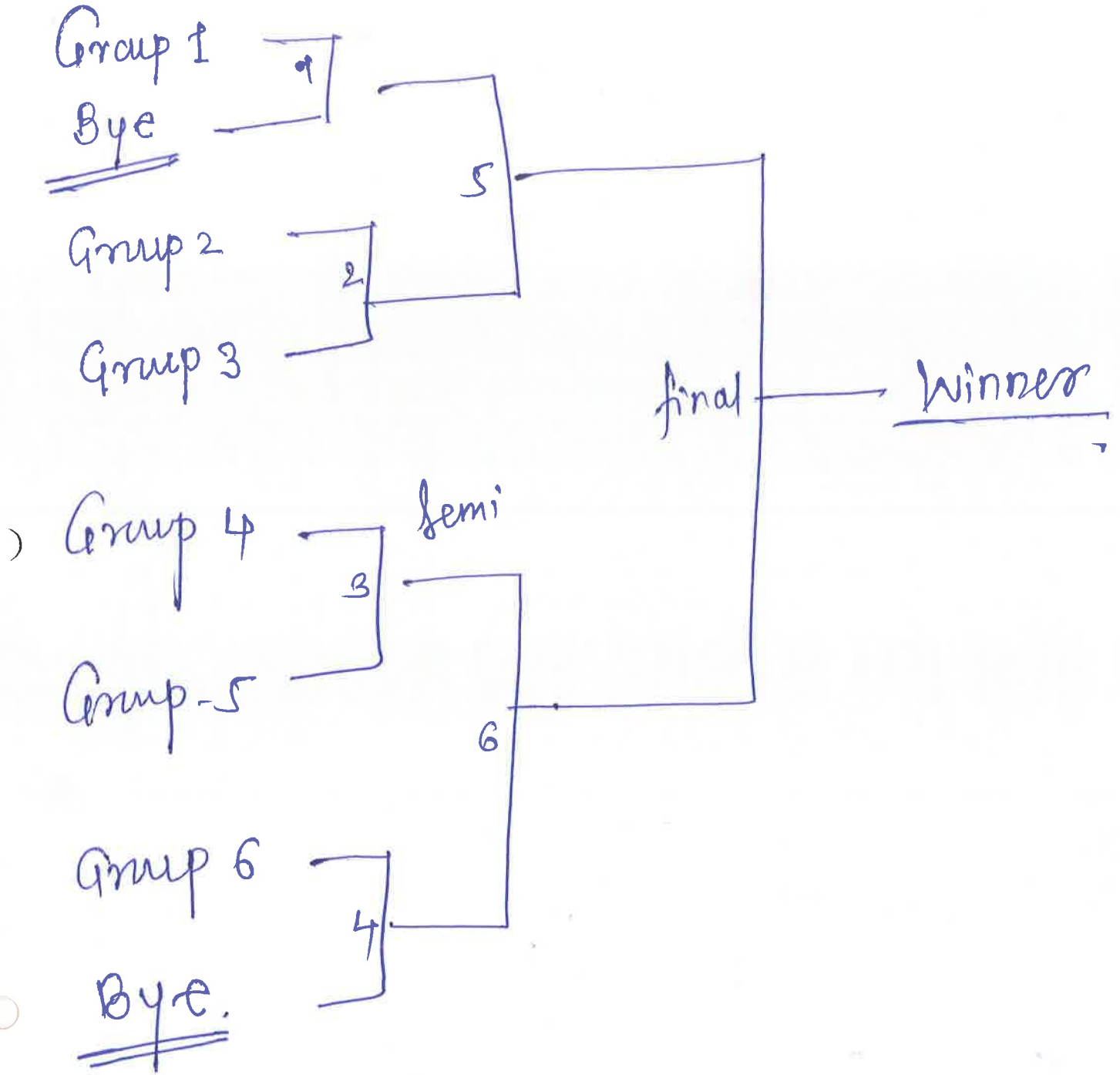

Handwritten title at the top of the page, possibly "Handwritten notes" or similar.

Handwritten text on the left side, possibly a date or page number.

Handwritten text on the left side, possibly a name or subject.

Handwritten text on the left side, possibly a name or subject.

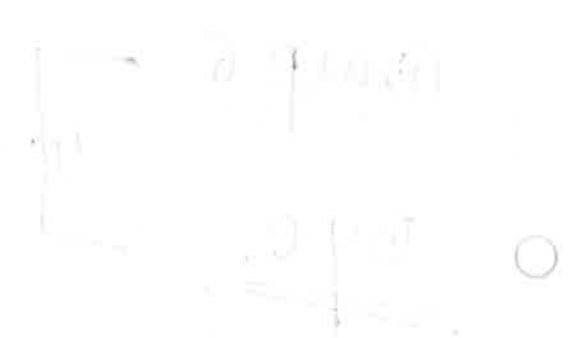



ZEEAL
INSTITUTES

www.zealeducation.com

NARHE | PUNE | INDIA

Redefining Excellence

Jr. COLLEGE | ITI | POLYTECHNIC | ENGINEERING | MBA | MCA | RESEARCH CENTRE



ZEAL EDUCATION SOCIETY'S

ZEAL COLLEGE OF ENGINEERING AND RESEARCH, PUNE-411

DEPARTMENT OF MECHANICAL ENGINEERING



MECHANICAL ENGINEERING STUDENT ASSOCIATION

Certificate of Appreciation

This certificate is awarded to Mr./Ms. Prachi Chirme for being Winner/
Runner/ Participant in Carrom Event during **MESA Sport League** organized by
Department of Mechanical Engineering in association with Mechanical Engineering Students
Association from 19th Jan. 2019 to 20th Jan. 2019.

Prof. Tamboli A.A.

Head of the Department



ZEAL
INSTITUTES

www.zealeducation.com
NARHE | PUNE | INDIA
Redefining Excellence



Jr. COLLEGE | IT | POLYTECHNIC | ENGINEERING | MBA | MCA | RESEARCH CENTRE

ZEAL EDUCATION SOCIETY'S

ZEAL COLLEGE OF ENGINEERING AND RESEARCH, PUNE-411

DEPARTMENT OF MECHANICAL ENGINEERING



MECHANICAL ENGINEERING STUDENT ASSOCIATION

Certificate of Appreciation

This certificate is awarded to Mr./Ms. Shreyash Bhosale for being Winner/
Runner/ Participant in Chess Event during MESA Sport League organized by
Department of Mechanical Engineering in association with Mechanical Engineering Students
Association from 19th Jan. 2019 to 20th Jan. 2019.

Prof. Tamboli A.A.

Head of the Department



ZEEAL
INSTITUTES

www.zeealeducation.com

NARHE | PUNE | INDIA

Re-defining Excellence

Jr. COLLEGE | ITI | POLYTECHNIC | ENGINEERING | MBA | MCA | RESEARCH CENTRE



ZEEAL EDUCATION SOCIETY'S

ZEEAL COLLEGE OF ENGINEERING AND RESEARCH, PUNE-411

DEPARTMENT OF MECHANICAL ENGINEERING

MECHANICAL ENGINEERING STUDENT ASSOCIATION

Certificate of Appreciation

This certificate is awarded to Mr./Ms. Akash Karade for being Winner/
Runner/ Participant in Cricket Event during **MESA Sport League** organized by
Department of Mechanical Engineering in association with Mechanical Engineering Students
Association from 19th Jan. 2019 to 20th Jan. 2019.

Prof. Tamboli A.A.

Head of the Department



ZEAL EDUCATION SOCIETY'S
ZEAL COLLEGE OF ENGINEERING AND RESEARCH
NARHE | PUNE -41 | INDIA
DEPARTMENT OF INFORMATION TECHNOLOGY



Department: IT

Semester: II

Academic Year: 2017-18

Date: 22/01/2018

The Zeal Education Society is organizing an event to form the largest human map. All students are invited to participate and be a part of this historic moment. The Date of event is 25/01/2018. Don't miss the opportunity to showcase your creativity and enthusiasm.

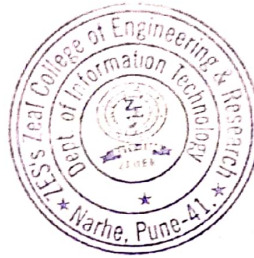

HOD

HOD

Dept. of Information Tech. Engg.
ZES's Zeal College
of Engineering & Research
Narhe, Pune - 411 041





Report on Largest Human Map of India-Bharat

Department: IT

Semester: II

Academic Year: 2017-18

Date: 27/01/2018

Introduction:

The "Largest Human Map of India-Bharat" was organized by the Zeal Education Society, Narhe Campus, Pune on 25/01/2018. The aim of the event was to create awareness about the geography and diversity of India and to showcase the unity and pride of being an Indian.

Highlights:

The event was a grand success, attracting a large number of participants. The following are some of the highlights of the event:

1. Over 1800+ students participated in forming the human map of India, with each student representing a state or union territory.
2. A display of the cultural diversity of India, with students dressed in traditional attire representing different regions of the country.
3. A display of the country's flag, with students singing the national anthem and shouting slogans of unity and patriotism.
4. The event received widespread media coverage, with several news outlets and media personalities showcasing the grand spectacle to a large audience

Conclusion:

The "Largest Human Map of India-Bharat" was a truly inspiring event, showcasing the unity and diversity of India. The organizers are to be commended for their efforts in creating an educational and patriotic experience for the participants. The event helped to instill a sense of pride and belonging among the students and raised awareness about the geography and culture of India. We hope to see similar events in the future.

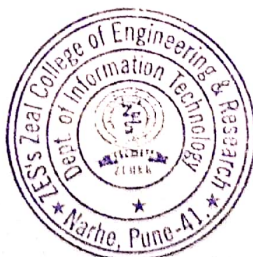



**ZEAL EDUCATION SOCIETY'S
ZEAL COLLEGE OF ENGINEERING AND RESEARCH
NARHE | PUNE -41 | INDIA
DEPARTMENT OF INFORMATION TECHNOLOGY**

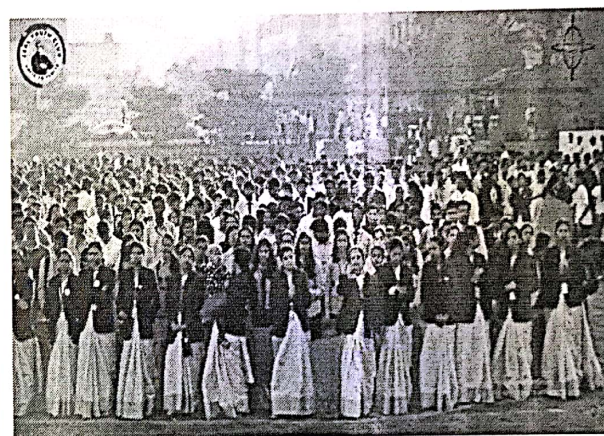
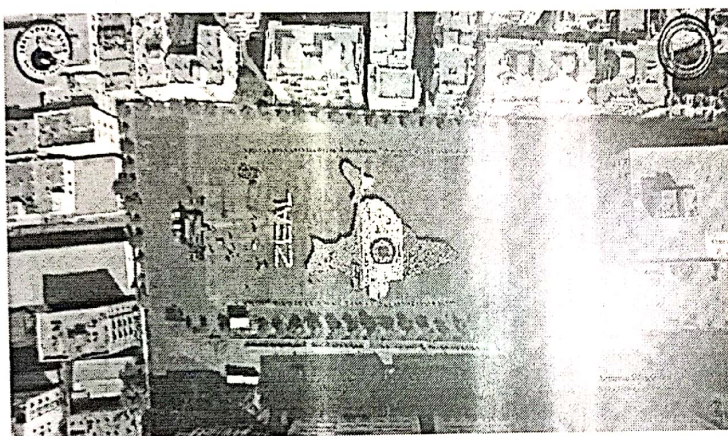
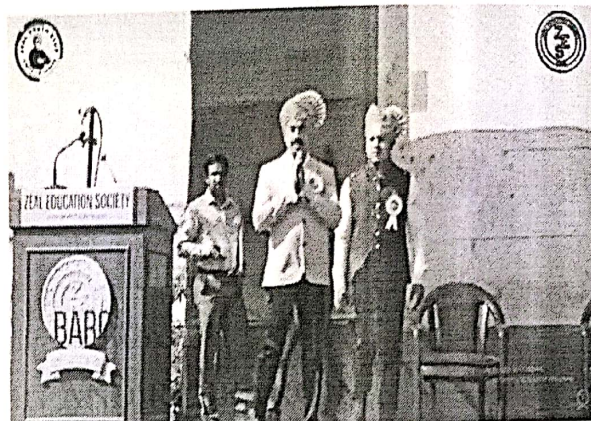
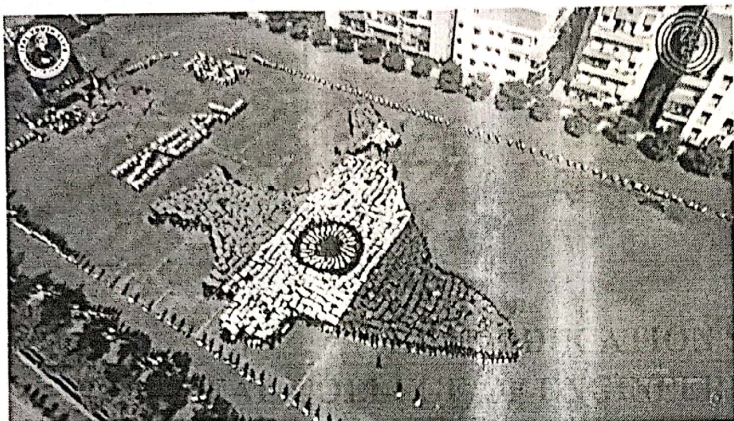

1800+ Students & Faculty members participated to form India Map on 25th January 2018

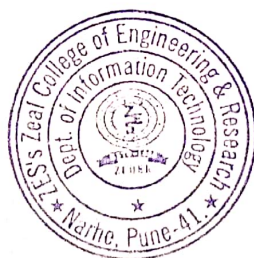

[Signature]

HoD

HoD
Dept. of Information Tech. Engg.
ZES's Zeal College
of Engineering & Research
Narhe, Pune - 411 004



ZEAL EDUCATION SOCIETY'S
ZEAL COLLEGE OF ENGINEERING AND RESEARCH
NARHE | PUNE -41 | INDIA
DEPARTMENT OF INFORMATION TECHNOLOGY



Department: IT

Semester: II

Academic Year: 2017-18

Date: 25/01/2018

Attendance

Sr.No	Roll No	Name	Class	Division	Present / Absent
1	S164001	ANPAT OMKAR SATISH	SE	A	Absent
2	S164002	BELHE RUGVED RAJENDRA	SE	A	Present
3	S164003	BHOSALE DIPALI BALAJI	SE	A	Present
4	S164004	BIRADAR SHEVANTA SURESH	SE	A	Absent
5	S164005	CHEDE ASHWINI GUNVANT	SE	A	Present
6	S164006	CHOUDHARY PRAJWAL	SE	A	Present
7	S164007	DHADIWAL RUSHABH ASHOK	SE	A	Present
8	S164008	DIHUMAL NIRANJAN DEVIDAS	SE	A	Present
9	S164009	DIGHE SHIVANI ANANT	SE	A	Present
10	S164010	DIVEKAR APOORVA SUNIL	SE	A	Present
11	S164011	DUKARE AKSHAY SURESH	SE	A	Present
12	S164012	G. MUNNESHWARI	SE	A	Present
13	S164013	GUJAR OMKAR SANJAY	SE	A	Absent
14	S164014	JADHAV AKASH DNYANESHWAR	SE	A	Present
15	S164015	JADHAV CHIRAG VIDYA	SE	A	Present
16	S164016	JAGTAP RAJNIKANT UMAKANT	SE	A	Present
17	S164017	KAKADE DEEPAK SANJAY	SE	A	Absent
18	S164018	KAKULATE RAJNISH DILIPRAO	SE	A	Present
19	S164019	KALBHOR TEJAS LAHU	SE	A	Present
20	S164020	KARALE SHUBHAM SHARAD	SE	A	Present
21	S164021	KATARE MAYUR KAMALAKAR	SE	A	Present
22	S164022	KHADKI SHUBHAM BABURAO	SE	A	Present
23	S164023	KHANDAGALE SHWETA SANJAY	SE	A	Present
24	S164024	KHOPADE KOMAL MAHESH	SE	A	Present
25	S164025	KIRVE APURVA SHIVAJI	SE	A	Present
26	S164026	KYATAMWAR NARESH BALAJI	SE	A	Present
27	S164027	MANE SUKRUT SAKHARAM	SE	A	Present
28	S164028	MARNE MRUNAL ANIL	SE	A	Present
29	S164029	MATHPATI UDAY RAJKUMAR	SE	A	Absent
30	S164030	NAIK SHUBHAM BHARAT	SE	A	Present
31	S164031	NANDESHWAR SAYALI DEWANAND	SE	A	Present
32	S164032	NIGHT SHUBHAM UDDHAV	SE	A	Present
33	S164033	PANHALE OM SUNIL	SE	A	Absent
34	S164034	PATEL PRIYANKA SANJAYBHAI	SE	A	Present
35	S164035	PATIL SHUBHAM SANTOSH	SE	A	Present
36	S164036	PHADTARE PRASANNA UDHAV	SE	A	Present
37	S164037	RANDALE MALHARI SANJEEV	SE	A	Absent
38	S164038	SAWAJI AMEY CHANDRAKANT	SE	A	Present
39	S164039	SHAIKH AZIM AZIZ	SE	A	Absent
40	S164040	WADGAONKAR KAUSTUBH KAILASRAO	SE	A	Present
41	S164041	WAGHMARE PRATIKSHA PRAKASH	SE	A	Present
42	S164042	WANI VAIBHAV MOTI	SE	A	Present
43	S164043	YEWALE SANKET SUBHASH	SE	A	Absent
44	S164044	ZAREKAR NILPRABHA VIJAY	SE	A	Absent

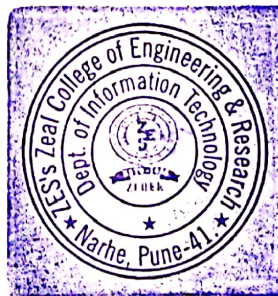



Department: IT

Semester: II

Academic Year: 2017-18

Date: 25/01/2018

Attendance

Sr.No	Roll No	Name	Class	Division	Present / Absent
1	T4001	Srushti Subhash Adarkar	TE	A	Present
2	T4002	Ifrah Samiuddin Ansari	TE	A	Present
3	T4003	Atharva Prashant Tillo	TE	A	Absent
4	T4004	Atishkumar Rajendra Oswal	TE	A	Present
5	T4005	Neha Rajendra Bairagi	TE	A	Present
6	T4006	Pranoti Chandrakant Dausode	TE	A	Absent
7	T4007	Tejas Bhandare	TE	A	Present
8	T4008	Ashish Govindrao Bhosale	TE	A	Present
9	T4009	Mina Vijay Bhosale	TE	A	Present
10	T4010	Ashwini Satish Bhujbal	TE	A	Present
11	T4011	Rutuja Rutuja Durate	TE	A	Present
12	T4012	Manuata Prakash Chavan	TE	A	Present
13	T4013	SHREENIVAS HANMANT CHAVAN	TE	A	Present
14	T4014	SWAPNALI GOKUL CHAVAN	TE	A	Present
15	T4015	Dinesh Mangilal Choudhari	TE	A	Present
16	T4016	Shubhadnya Dnyaneshwar Dhumal	TE	A	Present
17	T4017	Shambhavi Arun Dighe	TE	A	Absent
18	T4018	Dnyaneshwar Anirudh Chintaman	TE	A	Present
19	T4019	Suresh Mularam Dotale	TE	A	Present
20	T4020	PALLAVI PRAKASH DUKALE	TE	A	Present
21	T4021	Sadanand Anilkumar Gadve	TE	A	Present
22	T4022	MIRUNAL SACHIN GAIKWAD	TE	A	Absent
23	T4023	SAYALI SUDHAKAR GAIKWAD	TE	A	Present
24	T4024	Nikita Tejmal Gandhi	TE	A	Present
25	T4025	Mahesh Sukhdeo Gavali	TE	A	Present
26	T4026	Devashree Manohar Gharat	TE	A	Present
27	T4027	Gananjay Ninad Gharat	TE	A	Absent
28	T4028	VAISHNAVI DILIP GHODAKE	TE	A	Present
29	T4029	Priya Priya Ghodke	TE	A	Present
30	T4030	RUSHIKESH GIRISH GOKHALE	TE	A	Present
31	T4031	Shriram Pandit Goley	TE	A	Present
32	T4032	Hema Vilas Hadvale	TE	A	Present
33	T4033	Suraj Suhas Halkude	TE	A	Present
34	T4034	NINAD NANDEKISHOR JAGADE	TE	A	Present
35	T4035	Anuja Rajendra Jagdale	TE	A	Present
36	T4036	Mudholkar Rajesh Tejaswini	TE	A	Present

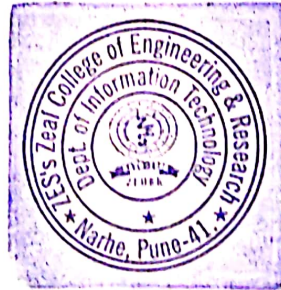



**ZEAL EDUCATION SOCIETY'S
ZEAL COLLEGE OF ENGINEERING AND RESEARCH
NARHE | PUNE -41 | INDIA
DEPARTMENT OF INFORMATION TECHNOLOGY**



Department: IT

Semester: II

Academic Year: 2017-18

Date: 25/01/2018

Attendance

Sr.No	Roll No	Name	Class	Division	Present / Absent
1	T4037	HARSHAL MORE	TE	B	Present
2	T4038	Pragati Babanrao Kale	TE	B	Absent
3	T4039	Shreyas Ramesh Kandgule	TE	B	Present
4	T4040	RUTUJA RAJENDRA KASHID	TE	B	Present
5	T4041	Vaibhav Mahadev Kntkar	TE	B	Present
6	T4042	Pooja Sakharan Knturde	TE	B	Absent
7	T4043	Gayatri SATISH Keskar	TE	B	Present
8	T4044	Sheetal Nitin Khandelwal	TE	B	Present
9	T4045	Sahil Nandkumar Kharse	TE	B	Present
10	T4046	Aadesh Rajendra Kharse	TE	B	Present
11	T4047	Rameshwari Shankar Konda	TE	B	Present
12	T4048	Riddhika Sanjay Kulkarni	TE	B	Present
13	T4049	Sarvesh Suresh Kulkarni	TE	B	Present
14	T4050	Siddhika Sanjay Kulkarni	TE	B	Present
15	T4051	Ojas Rajkumar Mahajan	TE	B	Present
16	T4052	Prachi Ajay Mahajan	TE	B	Present
17	T4053	Alikasim Mahedi	TE	B	Present
18	T4054	PRADNYA VIJAY MAINKAR	TE	B	Absent
19	T4055	Omkar Tukaram Margaje	TE	B	Present
20	T4056	Nisha Shankar Melkunde	TE	B	Present
21	T4057	Trupti Krishna Ji	TE	B	Present
22	T4058	Mokashi Satish Dhanashree	TE	B	Present
23	T4059	Nale Lalasaheb Rajesh	TE	B	Present
24	T4060	Nandurkar Balaji Nekhale	TE	B	Present
25	T4061	Krushnai Balaji Nirgude	TE	B	Absent
26	T4062	Pandole Kishor Rohan	TE	B	Present
27	T4063	PATIL RAVINDRA NIKITA	TE	B	Present
28	T4064	Pratik Sahdev Patil	TE	B	Present
29	T4065	Pratik Yashwant Patil	TE	B	Present
30	T4066	Akshay Amol Potnis	TE	B	Absent
31	T4067	Pranali Vikas Kshirsagar	TE	B	Present
32	T4068	Rajput Ramsing Apeksha	TE	B	Present
33	T4069	Ramdasi Mukund Kunal	TE	B	Present
34	T4070	Raskar Bhausaheb Kavita	TE	B	Present
35	T4071	Rawade Sopan Kunal	TE	B	Absent
36	T4072	Rewanwar Gajanan Manish	TE	B	Present
37	T4073	Sanas Kondaji Gaurav	TE	B	Present
38	T4074	ROHAN SUNIL SAPKAL	TE	B	Present
39	T4075	Dhanesh Kundalik Sarpale	TE	B	Absent
40	T4076	Kishor Tanaji Satpute	TE	B	Present
41	T4077	Saloni Vilas Satpute	TE	B	Present
42	T4078	Ashish Santosh Shanna	TE	B	Present
43	T4079	Akshay PRAKASH Shelatkar	TE	B	Present
44	T4080	Gauri Rajendra Shilamkar	TE	B	Present
45	T4081	ADITYA SUBHASH SHINDE	TE	B	Present
46	T4082	Pratik Suresh Shiinde	TE	B	Present
47	T4083	Aishwarya Deepak Shivane	TE	B	Present
48	T4084	Shinde Vikas Shreeyash	TE	B	Present
49	T4085	Rameez Khajamoinuddin Syed	TE	B	Present
50	T4086	Vishal Dattatrya Telang	TE	B	Present
51	T4087	Shrutika Deepak Tone	TE	B	Present
52	T4088	SHREYA SURESHKUMAR UPPALA	TE	B	Present
53	T4089	Akshay Anilkumar Uppin	TE	B	Present
54	T4090	Nikita Gajanan Wanare	TE	B	Present
55	T4091	Neal DILIP Yadav	TE	B	Present

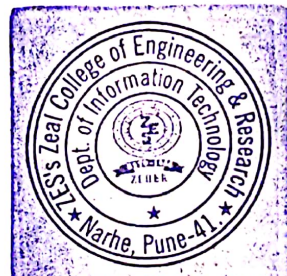



Department: IT

Semester: II

Academic Year: 2017-18

Date: 25/01/2018

Attendance

Sr.No	Roll No	Name	Class	Division	Present / Absent
1	B4001	Abhay Shahare	BE	A	Present
2	B4002	Viraj Maruti Chavan	BE	A	Absent
3	B4003	Pravesh Santosh Mandloi	BE	A	Present
4	B4004	Leelavati Chandrasekar Naidu	BE	A	Present
5	B4005	Akshay Mahesh Pawar	BE	A	Absent
6	B4006	Akshay Vasant Pilane	BE	A	Present
7	B4007	Mukul Kisan Sakat	BE	A	Present
8	B4008	Akhil Ayyub Sayyad	BE	A	Present
9	B4009	Akash Chandrashekhar Jadhav	BE	A	Present
10	B4010	Suresh Ramkisan Jadhav	BE	A	Present
11	B4011	Mangesh Ajit Kumbhar	BE	A	Present
12	B4012	Nikhil Vishwas Patil	BE	A	Present
13	B4013	Akash Narendra Pathak	BE	A	Present
14	B4014	Sachinkumar Ramesh Patil	BE	A	Present
15	B4015	Abhijeet Sawam	BE	A	Present
16	B4016	Ajay Sanjay Suryawanshi	BE	A	Present
17	B4017	Abhay Sunil Thite	BE	A	Present
18	B4018	Priyanka Nitin Thorbre	BE	A	Present
19	B4019	Tejaswini Ningappa Honkoli	BE	A	Present
20	B4020	Hitesh Dilip Khatate	BE	A	Present
21	B4021	Pankaj Prakash Thakur	BE	A	Present
22	B4022	Rohit Sanjaykumar Relan	BE	A	Present
23	B4023	Sheetal Rajendra Gaikwad	BE	A	Present
24	B4024	Akshay Bipin Naik	BE	A	Present
25	B4025	Pratiksha Mujumale	BE	A	Absent
26	B4026	Shshikant Balsane	BE	A	Present
27	B4027	Pratap Kush Sanjay	BE	A	Present
28	B4028	Kapase Aishvarya	BE	A	Absent
29	B4029	Gouri Dhamale	BE	A	Present
30	B4030	Varun Ashok Chavan	BE	A	Present



(Signature)

HOD

Dept. of Information Tech. Engg.
ZES's Zeal College
of Engineering & Research
Narhe, Pune - 411 004



ZEAL EDUCATION SOCIETY'S
ZEAL COLLEGE OF ENGINEERING AND RESEARCH
NARHE | PUNE -41 | INDIA
DEPARTMENT OF INFORMATION TECHNOLOGY



Department: IT

Semester: II

Academic Year: 2019-20

Date: 21/01/2020

The Zeal Education Society is organizing an event to form the Largest Human Flag of India and Human Portrait of Architects of Swarajya. All students are invited to participate and be a part of this historic moment. The Date of event is 25/01/2020. Don't miss the opportunity to showcase your creativity and enthusiasm.

Note: Attendance is mandatory to all students

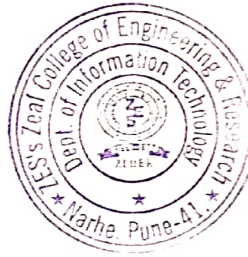

HOD

HOD
Dept. of Information Tech. Engg.
ZES's Zeal College
of Engineering & Research
Narhe, Pune - 411 001



Report on Human portraits of Architects of Swarajya

Department: IT

Semester: II

Academic Year: 2019-20

Date: 28/01/2020

On January 26th January 2020, Zeal College successfully attempted to create the largest human flag of India and a human portrait of the architects of Swarajya. The event was held at the college campus and witnessed a massive gathering of students, staff, and local residents.

The human flag of India was created with over 4000+ students, staff and volunteers forming the tri-color of the national flag. The flag measured an impressive and broke the previous record for the largest human flag of India.

The human portrait of the architects of Swarajya, on the other hand, was created with over 3500+ participants who formed a mosaic of Shri. Chatrapati Shivaji Maharaj, Rajmata Jijau and Tanaji Malusare. The portrait was created to honor the contribution of these leaders in the Indian independence movement and the framing of the Swarajya.

The event was a great success, and it received widespread media coverage, both locally and nationally. The event was also attended by several dignitaries, including local politicians, who praised the college for its effort in promoting national pride and unity.

In conclusion, the event was a great demonstration of the spirit of nationalism and unity. The college's attempt at creating the largest human flag of India and the human portrait of the architects of Swarajya was a remarkable feat, and it will be remembered as a significant milestone in the college's history.

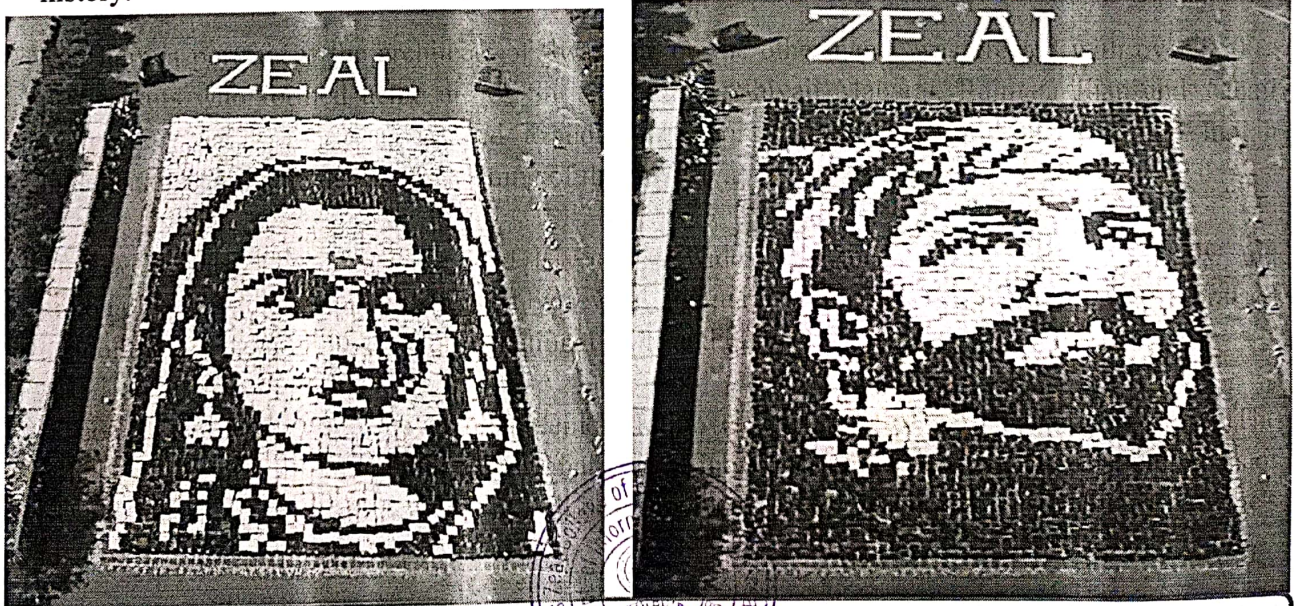

Human portrait of the Architects of Swarajya dated on 25th January 2020

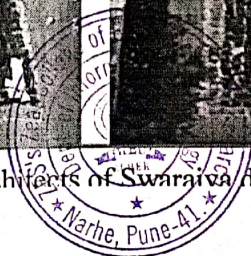



ZEAL EDUCATION SOCIETY'S
ZEAL COLLEGE OF ENGINEERING AND RESEARCH
NARHE | PUNE -41 | INDIA
DEPARTMENT OF INFORMATION TECHNOLOGY

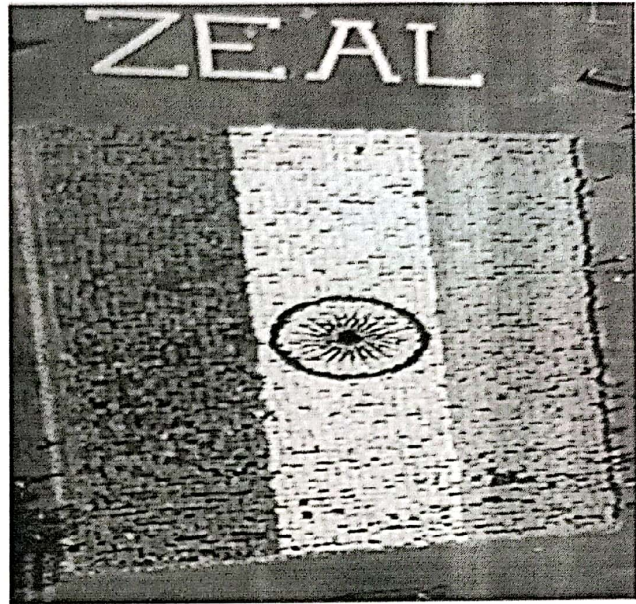

Human portrait of the Architects of Swarajya dated on 25th January 2020

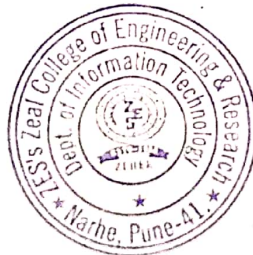

Chunil

HoD

HOD

Dept. of Information Tech. Engg
ZES's Zeal College
of Engineering & Research
Narhe, Pune - 411 004





Department: IT

Semester: II

Academic Year: 2019-20
Date: 25/01/2020

Sr.No	Roll No	Attendance			
		Name	Class	Division	Attendance
1	S511001	BARTAKKE OMKAR CHANDRAKANT	SE	A	P
2	S511002	BHANDARE PAVITRA PURANDAR	SE	A	A
3	S511003	BHARNE PRACHI RAJENDRA	SE	A	P
4	S511004	BHASMJE TEJAS SANDEEP	SE	A	P
5	S511005	BHUBAL SHUBHAM SATISH	SE	A	P
6	S511006	BICHUKALE SWARANJALI VILAS	SE	A	P
7	S511007	CHAUDHARY SIDDHANT HARBIKUMAR	SE	A	P
8	S511008	CHRISTINA GRACE NANDIGAM	SE	A	P
9	S511009	DEO SAMRUDDHI SUHAS	SE	A	A
10	S511011	GAIKWAD AKASH ARVIND	SE	A	P
11	S511013	GANATRA KOMAL RAJNIKANT	SE	A	A
12	S511014	GHATGE SHWETA KIRANKUMAR	SE	A	P
13	S511015	GOMARE VINISHA GOVIND	SE	A	P
14	S511016	ITNARE SARVESH NARIARI	SE	A	P
15	S511017	JADHAV TEJAS RUPESH	SE	A	A
16	S511018	JOSHI NAYANA GANESH	SE	A	P
17	S511019	JOSHI TEJAL PRASHANT	SE	A	P
18	S511021	KADAM ISHA BHARAT	SE	A	P
19	S511022	KADAM SHAMBHAWI SURENDRA	SE	A	A
20	S511024	KARANDE KUSUM SANJAY	SE	A	P
21	S511025	KHOT ANANT MANIK	SE	A	P
22	S511026	MALI HARSHVARDHAN SANJAY	SE	A	P
23	S511027	MANDAVKAR SAURABH NANDKUMAR	SE	A	P
24	S511028	MANSI SHAH	SE	A	A
25	S511029	MISAL NILESH MAHENDRA	SE	A	P
26	S511030	MOOLYA ABHISHEK DODDANNA	SE	A	P
27	S511031	NAGPURE SAHIL SANJEEV	SE	A	P
28	S511032	NANDPATIL TEJAS SANJAY	SE	A	P
29	S511033	PANDHARE ADITYA ARUN	SE	A	P
30	S511034	PARADKAR SUYASH YOGESH	SE	A	P
31	S511035	PATIL AKSHAY DNYANESHWAR	SE	A	P
32	S511037	PATIL PRAFULLA PITAMBAR	SE	A	P
33	S511038	PAWAR ANUSHKA CHANDRAKANT	SE	A	P
34	S511040	POHAKAR HARSHAL SANJAY	SE	A	P
35	S511042	PRABHUNE ATIJARVA P.	SE	A	P
36	S511043	RAHANE SASHA RAMNATH	SE	A	A
37	S511044	RAJPURE ABHAY KAILAS	SE	A	A
38	S511045	RAYKAR TEJAS RAVINDRA	SE	A	P
39	S511046	SARWADE SALONI SATISH	SE	A	P
40	S511047	SHETE SHUBHAM DNYANDEV	SE	A	P
41	S511048	SHINDE ADITYA ASHOK	SE	A	A
42	S511050	SINGH RAHUL RAJKUMAR	SE	A	P
43	S511051	THOOL ABHINAV PRAVIN	SE	A	P
44	S511055	ZORE SATISH DHONDIBA	SE	A	P
45	S511056	MATE ROHIT SURENDRA	SE	A	A
46	S511057	JANKAR SWARAJ SWARUPKUMAR	SE	A	P
47	S511058	DESHMUKH SAKSHI SUNIL	SE	A	P
48	S511059	DHAPADE PANKAJ PRABHU	SE	A	P
49	S511060	SAPKAL RUTUJA PANDURANG	SE	A	A
50	S511061	GAWADE PRAGATI BHANUDAS	SE	A	P
51	S511062	GHEWARE SAURABH SUNIL	SE	A	P

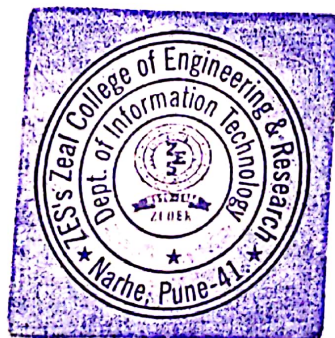



ZEAL EDUCATION SOCIETY'S
ZEAL COLLEGE OF ENGINEERING AND RESEARCH
NARHE, PUNE -41, INDIA
DEPARTMENT OF INFORMATION TECHNOLOGY



Department: IT

Semester: II

Academic Year: 2019-20
Date: 25/01/2020

Attendance					
Sr.No	Roll No	Name	Class	Division	Attendance
Sr.No	Roll No	Name	Class	Division	Attendance
1	T511002	AMANA SHLOK SHIVRAM	TE	A	A
2	T511004	ATTAR UMEERA ARIF	TE	A	A
3	T511005	AUTI RUSHIKESH SUKHADEV	TE	A	P
4	T511006	AWATE PUSIIKAR SANJAY	TE	A	P
5	T511008	BANNE BHAKTI VILAS	TE	A	P
6	T511009	BHAREKAR KRUTIKA ARUN	TE	A	P
7	T511010	BHIKULE CHETAN SHANKAR	TE	A	P
8	T511011	BHORDE ASHUTOSH YOGESH	TE	A	P
9	T511012	BHOSLE SHITAL SOMINATH	TE	A	A
10	T511013	BIRADAR SHEWANTA SURESH	TE	A	P
11	T511014	BIRARI SHUBHAM RAJENDRA	TE	A	P
12	T511015	BOBADE SWAPNIL VINOD	TE	A	A
13	T511016	BOBHATE GOURAV SURESH	TE	A	P
14	T511017	BORATE OM KISAN	TE	A	P
15	T511018	CHAUBEY SAURABHI	TE	A	P
16	T511019	CHAVAN PRADIP VASANT	TE	A	P
17	T511020	CHAVAN SHRIRAJ DILIP	TE	A	P
18	T511021	CHAWARE KETAN NITIN	TE	A	P
19	T511022	CHAWLA KARAN NARESH	TE	A	P
20	T511023	DAREKAR ANJALI ANGAD	TE	A	P
21	T511024	DESAI ATHARVA MILIND	TE	A	P
22	T511025	DESAI GAURAV RAVINDRA	TE	A	P
23	T511027	DESHMUKH SHUBHAM DILIP	TE	A	P
24	T511028	DESHPANDE VAIBHAV PRASANT	TE	A	A
25	T511029	DHANDE SHWETA WAMANRAO	TE	A	P
26	T511032	DOIPHODE VAIDEHI PRADEEP	TE	A	P
27	T511033	DOSHI VRUSHAL MAHAVIR	TE	A	A
28	T511034	DUBEY ADARSH RAKESH	TE	A	P
29	T511035	FATTEPURE POOJA BALBHIM	TE	A	P
30	T511036	GADE RUSHIKESH ANIL	TE	A	P
31	T511039	GAWARE AJAY DAGDUBA	TE	A	P
32	T511040	GHADGE SHWETA VILAS	TE	A	P
33	T511041	GHANEKAR SHASHIKANT SANJAY	TE	A	P
34	T511043	GOGAWALE SANYUKTA SANJAY	TE	A	P
35	T511044	GOLE SAISHREE MOHAN	TE	A	P
36	T511045	HONMORE SHUBHAM PRAFULLA	TE	A	P
37	T511046	JADHAV GOVIND GANESH	TE	A	P
38	T511047	JAGADE POOJA RAMCHANDRA	TE	A	P
39	T511049	JAINAPURE VIJAY MAHESH	TE	A	P
40	T511050	JAMDAR AKSHAY ARVIND	TE	A	P
41	T511052	KAD SACHIN NARAYAN	TE	A	A
42	T511053	KALBHOR DISHA HEMANT	TE	A	A
43	T511054	KAMBLE JYOTI ANIL	TE	A	A
44	T511055	KAMBLE SANJIWANI BANKAT	TE	A	A
45	T511056	KHURUD APURVA SHRIKANT	TE	A	A
46	T511057	KUDALE SAMIKSHA RAJU	TE	A	A
47	T511058	KULKARNI GAYATRI SUNIL	TE	A	P
48	T511059	KULKARNI RISHIKESH RAJENDRA	TE	A	P
49	T511060	KUMBHAR AKANKSHA MAHESH	TE	A	P
50	T511061	LANDGE MANSI BHAGWAN	TE	A	A
51	T511062	NAIK SHUBHAM BHARAT	TE	A	A
52	T511063	PATODEKAR AISHWARYA MADHAV	TE	A	P
53	T511064	WANARE NIKITA GAJANAN	TE	A	P
54	T511066	SHINDE BINDUMADHAV RAVINDRA	TE	A	P
55	T511067	MANE SUKRUT SAKHARAM	TE	A	P
56	T511068	KAKADE DEEPAK SANJAY	TE	A	P
57	T511069	NIGHT SHUBHAM UDDHAV	TE	A	P

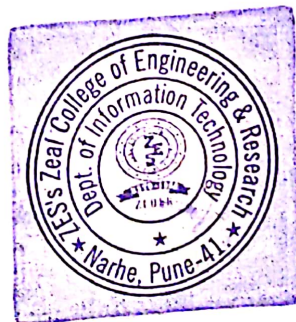



Department: IT

Semester: II

Academic Year: 2019-20
Date: 25/01/2020

Attendance					
Sr.No	Roll No	Name	Class	Division	Attendance
Sr.No	Roll No	Name	Class	Division	Attendance
1	T512001	LANJEKAR SAHIL SANDEEP	TE	B	A
2	T512002	LAVHATE ATUL SANJAY	TE	B	A
3	T512003	LOHAR AVADHUT PRASHANT	TE	B	A
4	T512004	MAHAMUNI AJAY SANJAY	TE	B	P
5	T512005	MALIKPETKAR ANAGHA PRAMOD	TE	B	P
6	T512007	MASKHE TEJAS JAYANT	TE	B	A
7	T512009	MULLA ARBAZ AKHTAR	TE	B	P
8	T512011	ORGANTIWAR SHIVAM SANJAY	TE	B	P
9	T512013	PANIKER ASHWATHY RAGHUNATH	TE	B	A
10	T512014	PARKAR BHUSHAN SANTOSH	TE	B	A
11	T512015	PARSUTKAR MAYUR GAJANAN	TE	B	P
12	T512016	PARTHE OMKAR GUNAJI	TE	B	P
13	T512017	PATIL BHAGYASHREE SANJAY	TE	B	A
14	T512018	PATIL GAURAV	TE	B	P
15	T512019	PATIL OMKAR PRAKASH	TE	B	P
16	T512020	PATIL VIVEK BALGONDA	TE	B	A
17	T512021	PAWAR SANKET HANMANT	TE	B	P
18	T512022	PAWAR SAURABH SHANKAR	TE	B	P
19	T512023	PAWAR SIDDHESH BABAN	TE	B	P
20	T512024	PINGLE SANIKA VIJAY	TE	B	P
21	T512025	PISE SAYALI ANIL	TE	B	P
22	T512026	POPHALE PRACHI RAJENDRA	TE	B	P
23	T512027	RAIBAGKAR ABHISHEK SANDEEP	TE	B	P
24	T512028	RAIKODE SHUBHANGI MANIKRAO	TE	B	P
25	T512029	RAJESHWARKAR RAHUL RAVINDRA	TE	B	P
26	T512030	RAJPUROHIT SHRIKRISHNA SURESHSINGH	TE	B	P
27	T512031	RASKAR VIKAS BHAGWANT	TE	B	P
28	T512032	ROKADE BHAGYASHREE JANKU	TE	B	P
29	T512033	SABALE AKSHAY ARJUN	TE	B	P
30	T512035	SANCHETI TANMAY JITENDRA	TE	B	P
31	T512036	SANKPAL OMKAR JAIDEEP	TE	B	P
32	T512037	SAPARIYA ASHWINI DINESH	TE	B	P
33	T512038	SAWANT AKANKSHA SURESH	TE	B	P
34	T512040	SAWANT YASHIPAL BHASKAR	TE	B	A
35	T512041	SHAIKH MUSKAN KADIR	TE	B	P
36	T512042	SHETYE SHAUNAK ANANT	TE	B	P
37	T512043	SHIGWAN DHANANJAY SANDEEP	TE	B	P
38	T512044	SHINDE AKASH MOHAN	TE	B	P
39	T512045	SHINDE JANHAVI DEEPAK	TE	B	P
40	T512046	SHINDE PRAJAKTA ANANDA	TE	B	P
41	T512047	SHINDE SHARWARI HEMANTKUMAR	TE	B	P
42	T512048	SHINTRE RUSHIKESH SATISH	TE	B	P
43	T512049	TAYDE MANALI PRAMODRAO	TE	B	P
44	T512050	THOPATE OMKAR NITIN	TE	B	P
45	T512051	UBHE VAISHNAVI RAJESH	TE	B	P
46	T512052	VAISHNAV VISHWANATH	TE	B	P
47	T512053	VARMA JAYDEEP SATISH	TE	B	P
48	T512054	WADEKAR SHASHANK SANJAY	TE	B	A
49	T512055	WAGHMARE ATHARVA ASHUTOSH	TE	B	P
50	T512056	WAGHUNDE PRANJAL PRASHANT	TE	B	A
51	T512057	WALEKAR VISHAL VIJAY	TE	B	P
52	T512058	WASHIVALE RAJ CHANDRAKANT	TE	B	P
53	T512059	WASKAR SHIVANI RAJKUMAR	TE	B	P
54	T512060	ZADBUKE VAISHNAVI CHANDRAKANT	TE	B	P
55	T512061	DANGI RITESH RAMLAL	TE	B	P
56	T512062	NADGIR ROHIT GANESH	TE	B	P
57	T512063	KULKARNI RIDDHIKA SANJAY	TE	B	P
58	T512064	MISTRY DURGESH RAJENDRA	TE	B	P
59	T512065	DARWATKAR RUCHITA RAMCHANDRA	TE	B	A
60	T512066	DIGHE SHIVANI ANANT	TE	B	P
61	T512067	JADHAV AKASH DNYANESHWAR	TE	B	P

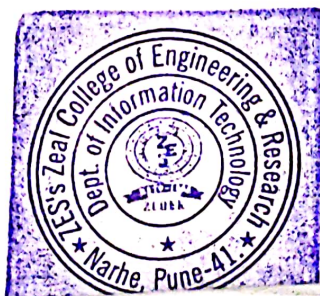



ZEAL EDUCATION SOCIETY'S
ZEAL COLLEGE OF ENGINEERING AND RESEARCH
NARHE, PUNE -41, INDIA
DEPARTMENT OF INFORMATION TECHNOLOGY



Department: IT

Semester: II

Academic Year: 2019-20
Date: 25/01/2020

Sr.No	Roll No	Name	Class	Division	Attendance
1	B511001	ADARKAR SRUSHTI SUBHASH	BE	A	A
2	B511003	AHIRE VANDITA ASHOK	BE	A	P
3	B511004	AHIWALE ABHIJEET ROHIDAS	BE	A	P
4	B511006	BACHKAR HRUSHIKESH SHIVRAM	BE	A	P
5	B511008	BELHE RUGVED RAJENDRA	BE	A	P
6	B511009	BHAGWAT MAYURESH RANGNATH	BE	A	A
7	B511011	BHOSALE DIPALI BALAJI	BE	A	P
8	B511012	BICHKAR VISHAKHA PRAMOD	BE	A	A
9	B511013	BORATE KARAN PRADEEP	BE	A	P
10	B511014	CHAVAN MAMATA PRAKASH	BE	A	P
11	B511015	CHAVAN RUPALI SUBHASH	BE	A	P
12	B511016	CHAVAN RUSHIKESH GOVARDHAN	BE	A	P
13	B511017	CHAVAN SAYALI PRAVIN	BE	A	P
14	B511018	CHAVAN SURAJ ANKUSH	BE	A	P
15	B511019	CHAVAN VIJAYMALA TUKARAM	BE	A	P
16	B511020	CHINTAMAN DNYANESHWAR ANIRUDH	BE	A	P
17	B511021	CHOUDHARY PRAJWAL ANIL	BE	A	P
18	B511025	DHALE JYOTI GANPAT	BE	A	P
19	B511026	DHAMDHARE OMKAR VIJAY	BE	A	P
20	B511027	DHOKCHAULE ASHWINI GOVIND	BE	A	P
21	B511028	DHUMAL NIRANJAN DEVIDAS	BE	A	P
22	B511029	G MANEESHWARI	BE	A	P
23	B511030	GHARAT DEVASHREE MANOHAR	BE	A	A
24	B511031	GIRI TEJAS SHASHIKANT	BE	A	A
25	B511032	GOMBI PRASHANT RAJSHEKHAR	BE	A	A
26	B511033	GONDCHAWAR SHREYA RAJESH	BE	A	P
27	B511034	GUDE SANDHYA SHIRIRANG	BE	A	P
28	B511035	GUGALE HONEY RAJENDRA	BE	A	P
29	B511036	GUJAR OMKAR SANJAY	BE	A	P
30	B511038	GUPTA JYOTI LALAN	BE	A	P
31	B511039	HIINDEKAR KAUSTUBH CHANDRASHEKHAR	BE	A	P
32	B511041	JAGDALE PAVANKUMAR SHARAD	BE	A	P
33	B511043	JANRAO SUHAS SUBHASH	BE	A	P
34	B511044	KACHI SHARAYU GAJENDRA	BE	A	P
35	B511045	KADAM PREMNATH ASHOK	BE	A	P
36	B511047	KALBHOR TEJAS LAHU	BE	A	P
37	B511049	RAJE ANIRUDDHA NANDKUMAR	BE	A	P
38	B511050	HADVALE HEMA VILAS	BE	A	P
39	B511051	CHAVAN SHREENIVAS HANMANT	BE	A	P
40	B511052	BHOSALE ASHISH GOVINDRAO	BE	A	P
41	B511053	SHINDE ADITYA SUBHASH	BE	A	P

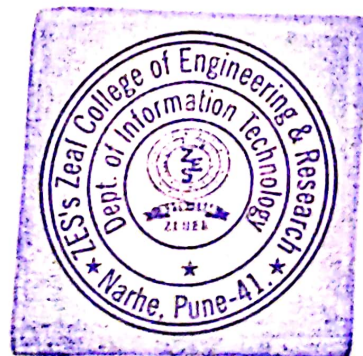



ZEAL EDUCATION SOCIETY'S
ZEAL COLLEGE OF ENGINEERING AND RESEARCH
NARHE | PUNE -41 | INDIA
DEPARTMENT OF INFORMATION TECHNOLOGY



Department: IT

Semester: II

Academic Year: 2019-20
Date: 25/01/2020

Sr.No	Roll No	Name	Class	Division	Attendance
1	B512002	KATKAR PRAVIN BHAUSO	BE	B	P
2	B512003	KHADE ADITI GANPAT	BE	B	P
3	B512004	KHADKI SHUBHAM BABURAO	BE	B	P
4	B512005	KHOT PALLAVI SURESH	BE	B	A
5	B512006	KIRVE APURVA SHIVAJI	BE	B	A
6	B512007	KOLAPE APARNA NANASAHEB	BE	B	A
7	B512008	KULKARNI PARAG SHASHIKANT	BE	B	A
8	B512009	KULKARNI VAIBHAV SUNIL	BE	B	P
9	B512010	MARGAJE OMKAR TUKARAM	BE	B	P
10	B512011	MIRZA ZINNEERAH FIRDOUS AFROZ BAIG	BE	B	P
11	B512012	MORE PAWAN KANTA	BE	B	P
12	B512013	NALE RAJESH LALASAHEB	BE	B	P
13	B512014	NANDESHWAR SAYALI DEWANAND	BE	B	P
14	B512016	PABALE SWATI DATTATRAY	BE	B	P
15	B512017	PANHALE OM SUNIL	BE	B	P
16	B512018	PANSARE SIMRAN VILAS	BE	B	P
17	B512019	PARDESHI PREM MANOJ	BE	B	P
18	B512021	PATIL AMRUTA SATAPPA	BE	B	P
19	B512023	PATIL NIRANJAN MURLIDHAR	BE	B	P
20	B512025	PATIL PRATIK SAHADEV	BE	B	P
21	B512026	PATIL SHUBHAM SANTOSH	BE	B	P
22	B512027	PAWAR SHUBHAM DATTATRAY	BE	B	P
23	B512028	PHADTARE PRASANNA UDHAV	BE	B	P
24	B512029	PINGALE KEDAR DILIP	BE	B	P
25	B512032	SANER PUSHKARAJ SANJAY	BE	B	P
26	B512033	SARAGE SAURABH SUNIL	BE	B	A
27	B512034	SHAIKH AZIM AZIZ	BE	B	P
28	B512035	SHAIKH HAZIM KHALIL	BE	B	P
29	B512036	SHINDE SHUBHAM VITTHAL	BE	B	P
30	B512038	SURWASE SUSHANT DAYANAND	BE	B	A
31	B512039	SURYAWANSHI AKSHATA MOHANRAO	BE	B	P
32	B512040	SURYAWANSHI SUKANYA TRAMBAKRAO	BE	B	P
33	B512043	TODKAR SATEJ SUDHIR	BE	B	P
34	B512044	TURE SWATI SUNIL	BE	B	A
35	B512046	VARMA ANKITKUMAR AMARNATH	BE	B	P
36	B512047	WANKHADE ANKITA GAJANAN	BE	B	A
37	B512048	YADAV ANURADHA SUKHADEV	BE	B	P
38	B512049	GAIKWAD MRUNAL SACHIN	BE	B	P
39	B512050	MUDHOLKAR TEJASWINI RAJESH	BE	B	A
40	B512051	HANVATE YOGESH BHIMRAO	BE	B	A
41	B512052	PANDOLE ROHAN KISHOR	BE	B	A
42	B512053	NIRGUDE KRUSHANAI BALAJI	BE	B	A
43	B512054	RASKAR KAVITA BHAUSAHEB	BE	B	P

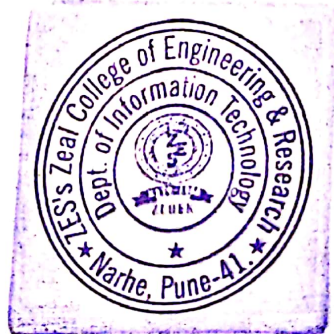

Dept. of Information Tech. Engg.
ZES's Zeal College
of Engineering & Research,
Narhe, Pune - 411 041

HOD





ZEAL EDUCATION SOCIETY'S
ZEAL COLLEGE OF ENGINEERING AND RESEARCH
NARHE | PUNE -41 | INDIA
DEPARTMENT OF INFORMATION TECHNOLOGY



Department: IT

Semester: II

Academic Year: 2018-19

Date: 15/02/2019

Invitation to Shri. Chatrapati Shivaji Maharaj Arms Exhibition

We are pleased to announce that the Zeal Education Society is hosting an exhibition on the arms and armor used by the legendary Maratha warrior-king, Shri. Chatrapati Shivaji Maharaj. This event offers a unique opportunity to learn about the military culture and tactics of the Maratha Empire during the 17th century.

The exhibition will feature various types of weapons, such as swords, spears, bows, and guns, as well as armor such as shields, helmets, and chest plates. Visitors will also have the chance to learn about the historical context of Shri. Chatrapati Shivaji Maharaj's reign, including his military campaigns, political alliances, and cultural impact.

The exhibition will be held on 19/02/2019 at IT Department Boys Room. We encourage all students to attend this informative and educational event. Entrance is free.

Please make sure to arrive on time and follow all the safety protocols. We look forward to seeing you there!

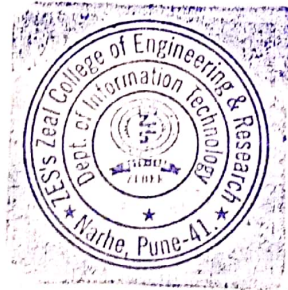

HOD
HOD

Dept. of Information Tech. Engrg
ZES's Zeal College
of Engineering & Research,
Narhe, Pune - 411 041





ZEAL EDUCATION SOCIETY'S
ZEAL COLLEGE OF ENGINEERING AND RESEARCH
NARHE | PUNE -41 | INDIA
DEPARTMENT OF INFORMATION TECHNOLOGY



Report on Cultural Exhibition

Department: IT

Semester: II

Academic Year: 2019-20

Date: 19/02/2020

The Shri. Chatrapati Shivaji Maharaj Fort Exhibition was held on 19/02/2020 at Zeal College of Engineering Narhe Campus [In front of building C]. The aim of the exhibition was to showcase the rich history and cultural heritage of the Maratha Empire and to educate the public about the architectural marvel of the fort.

Highlights:

The exhibition was a great success, attracting a large number of visitors and students. The following are some of the highlights of the event:

1. A detailed display of the history and significance of the fort, including its construction, expansion, and preservation efforts.
2. A virtual tour of the fort, including its various chambers, walls, and towers, which provided an immersive experience for visitors.
3. A showcase of traditional Maratha weapons, costumes, and jewelry, which highlighted the cultural richness of the era.
4. A presentation on the life and legacy of Shri Chatrapati Shivaji Maharaj, which provided a deeper understanding of the king's achievements and impact on Indian history.

Conclusion:

The Shri Chatrapati Shivaji Maharaj Fort Exhibition was a resounding success, providing a rich learning experience for visitors of all ages. The event helped to raise awareness about the importance of preserving our cultural heritage and the significance of the fort as a symbol of Maratha power and resilience. The organizers are to be commended for their efforts in making the exhibition a success, and we hope to see similar events in the future.

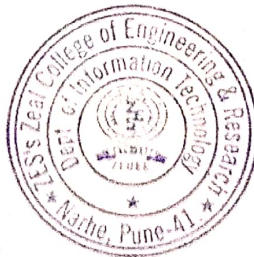

Report on Cultural Exhibition

Department: IT

Semester: II

Academic Year: 2018-19

Date: 19/02/2019

Shri. Chatrapati Shivaji Maharaj is a legendary Maratha warrior-king and folk hero in India, known for his military prowess and strategic leadership in the 17th century. An arm exhibition showcasing the weapons and armor used by Shivaji Maharaj is likely a significant event, as it offers a glimpse into the military culture and tactics of the Maratha Empire during this time period.

The exhibition may feature various types of weapons, such as swords, spears, bows, and guns, as well as armor such as shields, helmets, and chest plates. Visitors may also have the opportunity to learn about the historical context of Shivaji Maharaj's reign, including his military campaigns, political alliances, and cultural impact.

Such an exhibition is likely to attract a wide range of visitors, including history enthusiasts, students, and tourists, who are interested in learning about India's rich cultural heritage and military history. The exhibit may be displayed in a museum, cultural center, or other appropriate venue.

Overall, a Shivaji Maharaj arm exhibition is a valuable opportunity for students to engage with and learn about the rich cultural heritage and military history of India.

Total 1000+ students were visited this exhibition and learn about military culture and tactics of the Maratha Empire.

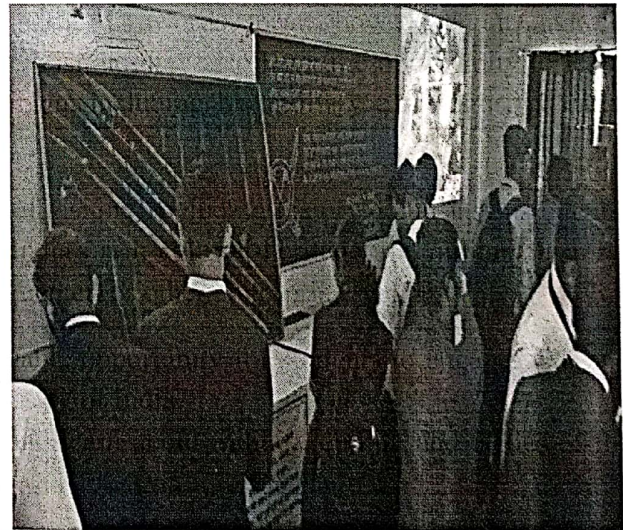
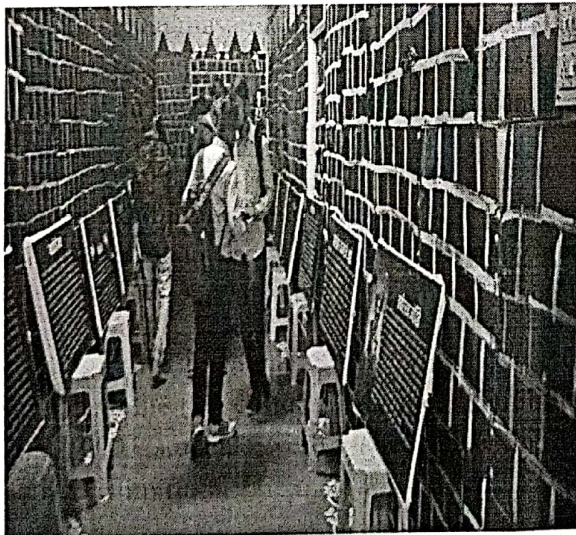

Glimpses of Shri. Chatrapati Shivaji Maharaj Arms Exhibition on 19th February 2019

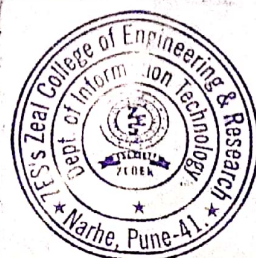



Department: IT

Semester: II

Academic Year: 2018-19

Date: 19/02/2019

Attendance

Sr.No	Roll No	Name	Attendance
1	S41001	ABHANG GAYATRI SUNIL	P
2	S41002	BHIIKULE CHETAN SHANKAR	P
3	S41003	BIRADAR SHEWANTA SURESH	P
4	S41004	BOBHATE GOURAV SURESH	P
5	S41005	BORATE OM KISAN	P
6	S41006	CHAUBHEY SAURABHI	P
7	S41007	CHAWLA KARAN NARESH	P
8	S41008	CHEDE ASHWINI GUNAWANT	P
9	S41009	DESAI ATHARVA MILIND	P
10	S41010	DIIANDE SHIWETA WAMANRAO	P
12	S41012	DIVEKAR APOORVA SUNIL	P
13	S41013	DUBEY ADARSH RAKESH	P
14	S41014	GHARGE MAYURI SUBHASH	P
15	S41015	GOGAWALE SANYUKTA SANJAY	P
16	S41016	GOLE SAISHREE MOHAN	P
24	S41024	PANIKER ASHWATHY RAGHUNATH	P
25	S41025	PARSUTKAR MAYUR GAJANAN	P
26	S41026	PINGLE SANIKA VIJAY	P
27	S41027	ROKADE BHAGYASHREE JANKU	P
28	S41028	SABALE AKSHAY ARJUN	P
29	S41029	SANKPAL OMKAR JAIDEEP	P
34	S41034	TAYDE MANALI PRAMODRAO	P
35	S41035	UBHE VAISHNAVI RAJESH	P
36	S41036	VAISHNAV VISHWANATH	P
37	S41037	WADEKAR SHASHANK SANJAY	P
38	S41038	WAGHMARE ATHARVA ASHUTOSH	P
39	S41039	WAGHUNDE PRANJAL PRASHANT	P
40	S41040	JADHAV GOVIND GANESH	P
41	S41041	TRIPATHI SHUBHAM RAMAYANPRASAD	P
1	S41042	AMANA SHLOK SHIVRAM	P
2	S41043	ATTAR Umera ARIF	P
3	S41044	AUTI RUSHIKESH SUKHADEV	P
4	S41045	AWATE PUSHKAR SANJAY	P
5	S41046	BANE YOGESH YASHWANT	P
6	S41047	BANNE BHAKTI VILAS	P
7	S41048	BHAREKAR KRUTIKA ARUN	P
8	S41049	BHORDE ASHUTOSH YOGESH	P
16	S41057	DESAI GAURAV RAVINDRA	P
17	S41058	DESAI RUTT SANJAY	P
18	S41059	DESHMUKH SHUBHAM DILIP	P
19	S41060	DESHPANDE VAIBHAV PRASANT	P
20	S41061	DOIPHODE VAIDEHI PRADEEP	P
21	S41062	DOSHI VRUSHAL MAHAVIR	P
22	S41063	FATTEPURE POOJA BALBHIM	P
23	S41064	GADE RUSHIKESH ANIL	P
24	S41065	GAUND SIDDHANT RAMDAS	P
25	S41066	GAWADE SAATVIK SHIVAJI	P
26	S41067	GAWARE AJAY DAGDUBA	P

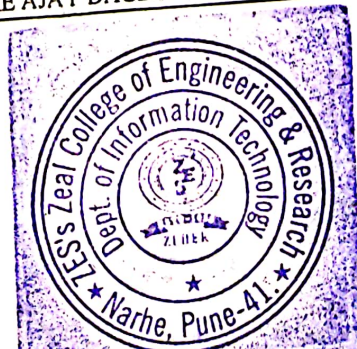



Department: IT

Semester: II

Academic Year: 2018-19

Date: 19/02/2019

Attendance

Sr.No	Roll No	Name	Attendace
37	S41078	KUDALE SAMIKSHA RAJU	P
38	S41079	KULKARNI GAYATRI SUNIL	P
39	S41080	KULKARNI RISHIKESH RAJENDRA	P
40	S41081	KUMBHAR AKANKSHA MAHESH	P
41	S41082	LANJEKAR SAHIL SANDEEP	P
42	S41083	LAVHATE ATUL SANJAY	P
43	S41084	LOHAR AVADHUT PRASHANT	P
44	S41085	MAHAMUNI AJAY SANJAY	P
45	S41086	MALIKPETKAR ANAGHA PRAMOD	P
46	S41087	MANER TAHIR ISMAIL	P
47	S41088	MASKHE TEJAS JAYANT	P
48	S41090	MULLA ARBAZ AKHTAR	P
49	S41091	NANAVARE AMIT NAVNATH	P
50	S41092	PAGARE SHUBHAM VIJAY	P
51	S41093	PARKAR BHUSHAN SANTOSH	P
52	S41094	PARTHE OMKAR GUNAJI	P
53	S41095	PATIL BHAGYASHREE SANJAY	P
54	S41096	PATIL OMKAR PRAKASH	P
55	S41097	PATIL VIVEK BALGONDA	P
56	S41098	PAWAR SANKET HANMANT	P
57	S41099	PAWAR SIDDHESH BABAN	P
58	S41100	PISE SAYALI ANIL	P
59	S41101	POPHALE PRACHI RAJENDRA	P
70	S41112	SHINDE PRAJAKTA ANANDA	P
71	S41113	SHINDE SHARWARI HEMANTKUMAR	P
72	S41114	SHINTRE RUSHIKESH SATISH	P
73	S41115	THOPATE OMKAR NITIN	P
74	S41116	VARMA JAYDEEP SATISH	P
75	S41117	WALEKAR VISHAL VIJAY	P
76	S41118	WASHIVALE RAJ CHANDRAKANT	P
77	S41119	WASKAR SHIVANI RAJKUMAR	P
78	S41120	ZADBUKE VAISHNAVI CHANDRAKANT	P
79	S41121	ATHAVALE ADVAIT SUNIL	P
80	S41122	KHABALE PRAMOD RAMAN	P
81	S41123	PATIL GAURAV	P
82	S41124	PAWAR SAURABH SHANKAR	P
83	S41125	RAJPUROHIT SHRIKRISHNA SUREHSINGH	P
84	S41126	SHINDE JANHAVI DEEPAK	P
1	T41001	ADARKAR SRUSHTI SUBHASH	P
2	T41002	ADAWADE TANVI SANJAY	P
3	T41003	AHIRE VANDITA ASHOK	P
4	T41004	AHIWALE ABHIJEET ROHIDAS	P
5	T41005	ALI KASIM ILIYAS MAHEDI	P
6	T41006	BACHKAR HRUSHIKESH SHIVRAM	P
9	T41009	BHAGWAT MAYURESH RANGNATH	P
10	T41010	BHALERAO ANAND GORAKHANATH	P
11	T41011	BHOSALE DIPALI BALAJI	P
12	T41012	BICHKAR VISHAKHA PRAMOD	P

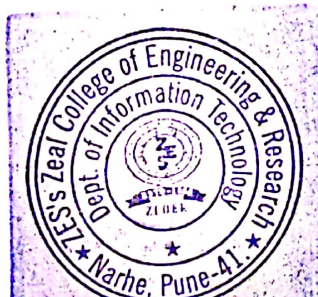



Department: IT

Semester: II

Academic Year: 2018-19

Date: 19/02/2019

Attendance

Sr.No	Roll No	Name	Attendance
13	T41013	BORATE KARAN PRADEEP	
14	T41014	CHAVAN MAMATA PRAKASH	P
15	T41015	CHAVAN RUPALI SUBHASHI	P
16	T41016	CHAVAN RUSHIKESH GOVARDHAN	P
19	T41019	CHAVAN VIJAYMALA TUKARAM	P
20	T41020	CHINTAMAN DNYANESHWAR ANIRUDH	P
21	T41021	CHOUDHARY PRAJWAL ANIL	P
22	T41022	CHOUIHAN AKANKSHA ASHISH	P
23	T41023	DARWATKAR RUCHITA RAMCHANDRA	P
24	T41024	DAWANDE MAYUR ATUL	P
26	T41026	DHALE JYOTI GANPAT	P
27	T41027	DHAMDIHERE OMKAR VIJAY	P
30	T41030	G. MUNNESHWARI	P
31	T41031	GHARAT DE-VASHIREE MANOHAR	P
32	T41032	GIRI TEJAS SHASHIKANT	P
33	T41033	GOMBI PRASHANT RAJSHEKHAR	P
34	T41034	GONDCHAWAR SHREYA RAJESH	P
35	T41035	GUDE SANDHYA SHRIRANG	P
36	T41036	GUGALE HONEY RAJENDRA	P
37	T41037	GUJAR OMKAR SANJAY	P
38	T41038	GUNDLE BALAJI SANGAMNATH	P
39	T41039	GUPTA JYOTI LALAN	P
41	T41041	JADHAV AKSHAY BALASAHEB	P
42	T41042	JAGADALE PAVANKUMAR SHARAD	P
43	T41043	JAGTAP ADITYA PRAKASH	P
44	T41044	KACHI SHARAYU GAJENDRA	P
45	T41045	KADAM PREMNATH ASHOK	P
46	T41046	KALAL AISHWARYA NARSING	P
47	T41047	KALBHOR TEJAS LAHU	P
48	T41048	KALE RADHIKA DHANANJAY	P
49	T41049	KARVE NUPUR PRAVIN	P
50	T41050	KATKAR PRAVIN BHAUSO	P
1	T41051	KHADE ADITI GANPAT	P
2	T41052	KHADKI SHUBHAM BABURAO	P
3	T41053	KHOT PALLAVI SURESH	P
4	T41054	KIRVE APURVA SHIVAJI	P
5	T41055	KOLAPE APARNA NANASAHEB	P
6	T41056	KULKARNI PARAG SHASHIKANT	P
7	T41057	KULKARNI VAIBHAV SUNIL	P
8	T41058	MANE SUKRUT SAKHARAM	P
9	T41059	MARGAJE OMKAR TUKARAM	P
10	T41060	MIRZA ZINNEERAH FIRDOUS AFROZ BAIG	P
11	T41061	MORE PAWAN KANTA	P
12	T41062	NAIK SHUBHAM BHARAT	P
41	T41091	SURYAWANSHI AKSHATA MOHANRAO	P
42	T41092	SURYAWANSHI SUKANYA TRAMBAKRAO	P
43	T41093	TELANG VISHAL DATTATRYA	P

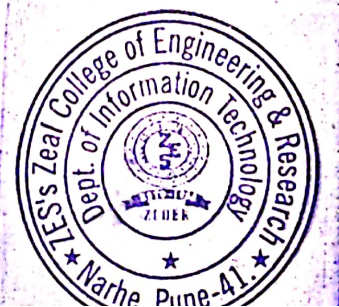



Department: IT

Semester: II

Academic Year: 2018-19

Date: 19/02/2019

Attendance			Attendance
Sr.No	Roll No	Name	
44	T41094	TILLU ATHARVA PRASHANT	P
49	T41099	WANKHEDE ANKITA GAJANAN	P
50	T41100	YADAV ANURADHA SUKHADEV	P
51	T41101	WANARE NIKITA GAJANAN	P
52	T41102	ANSARI IFRAH SAMI UDDIN	P
53	T41103	JANRAO SUHAS SUBHASHI	P
2	B41002	Bairagi Neha Rajendra	P
3	B41003	Bansode Pranoti Chandrakant	P
4	B41004	BARAHATE HIMANI PRAMOD	P
5	B41005	Bhoite Sneha Murlidhar	P
6	B41006	Bhosale Mira Vijay	P
7	B41007	Bhujbal Ashwini Satish	P
9	B41009	Chavan Aditi Mahesh	P
10	B41010	CHAVAN SHREENIVAS HANMANT	P
11	B41011	CHAVAN SWAPNALI GOKUL	P
12	B41012	Choudhari Dinesh Mangilal	P
13	B41013	DHANURE PRIYA RAMRAO	P
14	B41014	Dhumal Shubhadnya Dnyaneshwar	P
15	B41015	Dighe Shambhavi Arun	P
16	B41016	DUKALE PALLAVI PRAKASH	P
17	B41017	Gadve Sadanand Anilkumar	P
18	B41018	GAIKWAD MRUNAL SACHIN	P
19	B41019	GAIKWAD SAYALI SUDHAKAR	P
24	B41024	Hadvale Hema Vilas	P
25	B41025	JADHAV AKASH CHANDRASHEKHAR	P
26	B41026	Jagdale Anuja Rajendra	P
27	B41027	Kandgule Shreyas Ramesh	P
28	B41028	KASHID RUTUJA RAJENDRA	P
29	B41029	Katkar Vaibhav Mahadev	P
30	B41030	Katurde Pooja Sakhamam	P
31	B41031	Keskar Gayatri Satish	P
34	B41034	Kshirsagar Pranali Vikas	P
1	B41035	Kulkarni Sarvesh Suresh	P
2	B41036	Mahajan Prachi Ajay	P
3	B41037	MAINKAR PRADNYA VIJAY	P
4	B41038	Melkunde Nisha Shankar	P
5	B41039	MOHITE TRUPTI KRISHNAJI	P
6	B41040	Mokashi Dhanashree Satish	P
23	B41057	Sharma Ashish Santosh	P
24	B41058	Shelatkar Akshay Prakash	P
25	B41059	Shilamkar Gauri Rajendra	P
26	B41060	Shinde Pratik Suresh	P
27	B41061	Shinde Shriyash Vikas	P
28	B41062	Shivane Aishwarya Deepak	P
29	B41063	THATTE UMA VIJAY	P
31	B41065	UPPALA SHREYA SURESHKUMAR	P
32	B41066	Uppin Akshay Anilkumar	P
33	B41067	Yadav Neal Dilip	P

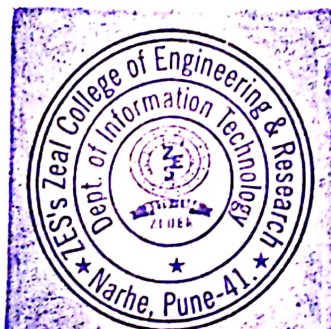



ZEAL EDUCATION SOCIETY'S
ZEAL COLLEGE OF ENGINEERING AND RESEARCH
NARHE | PUNE -41 | INDIA
DEPARTMENT OF INFORMATION TECHNOLOGY



Department: IT

Semester: II

Academic Year: 2018-19

Date: 19/02/2019

Attendance

Sr.No	Roll No	Name	Attendance
34	B41068	Dotalesa Suresh Mularam	P
35	B41069	Bhosale Ashish Govindrao	P
37	B41071	Nirgude Krushnai Balaji	P
38	B41072	Parbhane Akash Jalindar	P

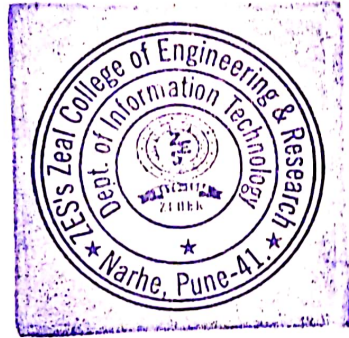

HOD
Dept. of Information Tech. Engg.
ZES's Zeal College
of Engineering & Research,
Narhe, Pune - 411 041